

THE INTELLIGENT COUPLING.



PRODUCT PORTFOLIO

SENSOR TECHNOLOGY

R+W is one thing above all: **THE COUPLING.**

The company **Who we are**

Day after day, we at R+W make the impossible possible and drive technology for tomorrow. Our couplings are usually only a small component of larger solutions - but they are a decisive factor when it comes to moving components.

Close by worldwide

From our headquarters in Wörth am Main, Germany, we operate as a global industrial enterprise and maintain subsidiaries and sales offices in Italy, France, Slovakia, the USA, China and Singapore.

We attach great importance to close cooperation with our customers and partners. Our goal is to provide our customers with outstanding technical advice and individual development services. That is why we promote our strong and extensive network of more than 80 premium partners and are represented worldwide in over 65 countries close to the market.

Since our founding in 1990, we have developed into the technology leader with in-depth coupling know-how. From batch size 1 we tackle new projects together and implement them consistently.

We produce and deliver more than 1,000,000 couplings annually around the world, from our production facilities in Germany, Slovakia and the USA.



Sustainable Principles

Ecological. Social. Economic. Sustainable development is only possible if we give equal weight to economic growth, social security and ecological compatibility on an equal footing. Our sustainability initiatives take this into account. They span all areas of the company and provide a comprehensive and reliable framework for responsible use of resources.



Natural progress

We are striving to gradually move closer to our goal of zero emissions. To this end, we constantly monitor our consumption levels and rely on technologies and equipment with high resource efficiency. Green energy for our production is provided by a 180-kWp photovoltaic system. The purchased energy comes 100% from hydrogen. We reduce process water through targeted fine filtration and cascading.

Social plus

Here, the focus is on those who are the plus at R+W: our employees. We place occupational health and safety at the top of our agenda, and provide continuous investment in this area. A high level of process reliability guarantees the high quality of our couplings and ensures the benefit for our customers.

Long-term value

For success to be sustainable, we must think economically. The prerequisite for this is a modern infrastructure, continuous process improvement in the value chain and cooperation with sustainable suppliers and service providers.



Implementation How we succeed with Forward thinking



Smart future here today!

With the Intelligent Coupling from R+W Antriebselemente, we are setting a sign for modern developments in the course of digitalization, automation and the Industrial Internet of Things (IIoT).

As a technology leader and specialist, we recognized this early on: The transformation to networked Industry 4.0 cannot be avoided. Data and its efficient use are becoming increasingly valuable. We do not want to simply but to actively help shape it for our customers and turn it into reality.

In drive technology, real-time data acquisition has been a major challenge. The reason: a rotating drive axis cannot be easily connected to a cable – until now! Thanks to the Intelligent Coupling from R+W, this situation has changed fundamentally.

R+W Milestones

1993



Development of the first plug-in metal bellows coupling on the market

New technical standards and superior competitive advantage in elastomer couplings



1999

2001-
2004



International openings:
USA (sales office), Slovakia (component production) and China (sales office)

New standard for TÜV tested safety couplings + development of a special safety coupling for the International Space Station



2006

More R+W Couplings

For further information and products please refer to our catalogs of precision and/or industrial couplings.



The new generation of coupling: Intelligent couplings with built-in sensor technology



2008



Additional site opening in Italy

2020

2023



Sales office in Chicago becomes a full production facility

6 Measurement types 3 power supply systems **One perfect solution.**

Can be integrated into existing Applications

No additional installation space necessary, simple sensor retrofitting in already installed couplings

Compatible with many Couplings

Suitable for metal bellows couplings, line shafts, disc pack couplings and flanges

Extensive and precise measurement data

Better assessment of the dynamic behavior in the rotating drive line

Extremely smart and economical Solution

Without high integration costs or complex commissioning

Combinable and time-dependent- Measured variables

Various scalable diagram types track the the detailed course of the measured variables

More transparency ensures more security

Critical data at all times - with the R+W App on your smart-phone or tablet



Sensor technology from R+W

Next level information

page 8 - 13

The measuring chain	8
Sensor packages	9
Energy supply	10
R+W App	11
Gateway	12 - 13

Sensor technology can be integrated into...

 **Metal bellow couplings**  16 - 17

 **Line shafts**  18 - 20

 **Disc pack couplings**  21 - 24

 **Rigid flanges**  25

The measuring chain

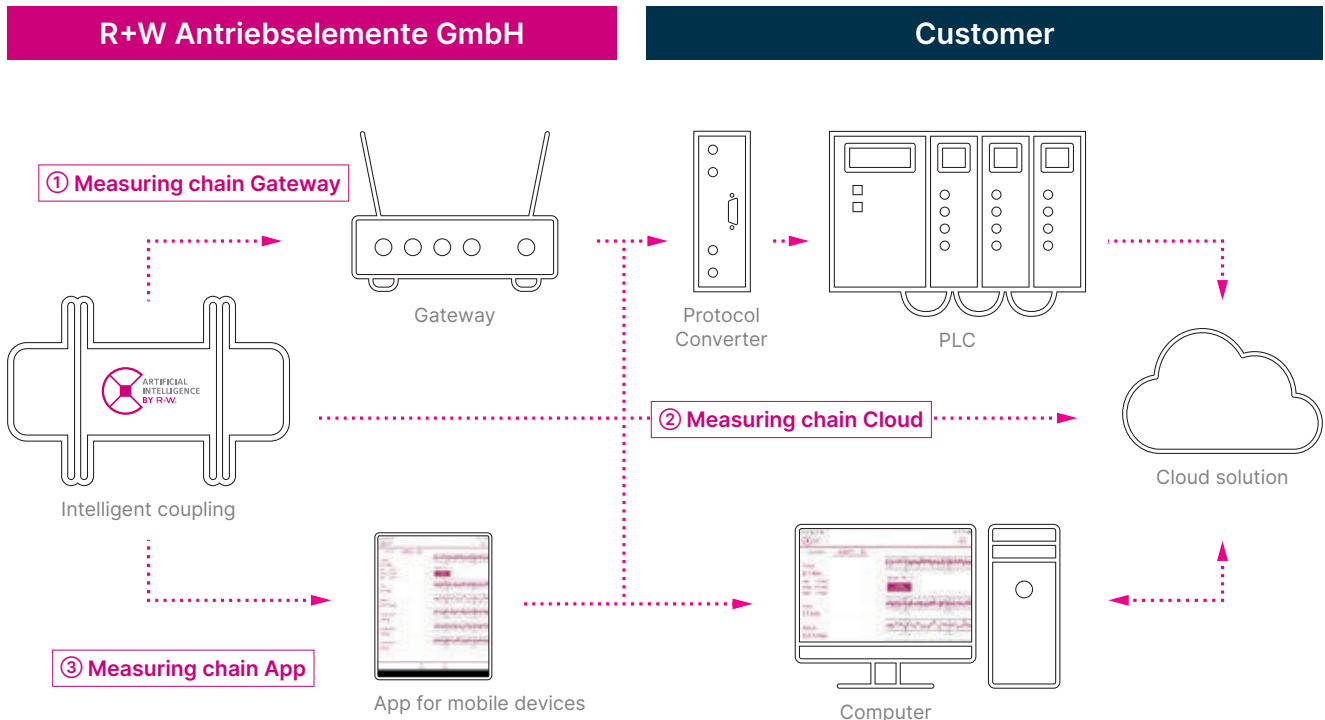

① Measuring chain Gateway

Intelligent coupling → gateway → machine control or computer.

In this case, the coupling connects to one of the gateways via Bluetooth. Machine controls can be connected via various interfaces. Connection to a PC or cloud based system is also possible.

② Measuring chain Cloud

Intelligent coupling → Cloud

By selecting an LTE measurement amplifier, cloud data transmission is possible.

③ Measurement chain App

Intelligent coupling → App or computer

The measurement chain app connects the coupling to a mobile device via Bluetooth. In the app developed by R+W, the measurement data can be displayed and saved. It is also possible to export the stored CSV file to a PC.

Sensor packages

Standard

Features

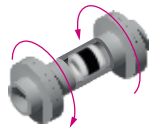

+ Torque

Standard measuring range: 2 - 10,000 Nm
Deviation: 0.5 - 1 %
Resolution: 24 bit
Sampling rate: up to 1,000 Hz

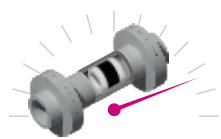

+ Speed

Deviation (up to 660 rpm): 0.5
Deviation (up to 2,500 rpm): 5 %
Resolution: 16 bit
Sampling rate: up to 1,000 Hz

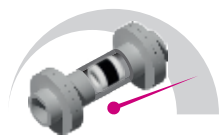

+ Acceleration

Number of axes: 3 (x, y, z)
Deviation: 1 - 5
Resolution: 16 bit
Sampling rate: up to 1,000 Hz

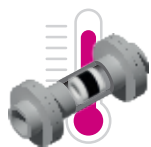

+ Temperature

Accuracy: 2 K
Resolution: 8 bit
Sampling rate: 10 Hz

Optional (only one other option can be selected)

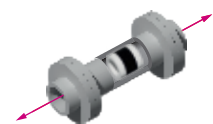

+ Axial force

Standard measuring range: 50 - 125,000 N
Deviation: 0,5 - 2 %
Resolution: 24 bit
Sampling rate: up to 1,000 Hz

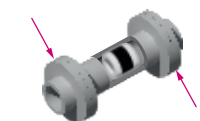

+ Shear force/bending

Standard measuring range: 50 - 125,000 N
Deviation: 1 - 5
Resolution: 24 bit
Sampling rate: up to 1,000 Hz



In addition to the standard gauges, the application of "bridges" can be generated by applying more strain gauges. A second channel can be generated to also measure the axial force or shear force.

Energy supply

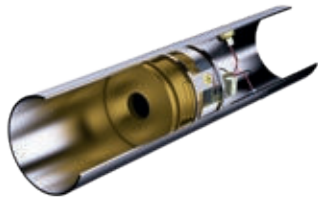

Battery

The sensor system is supplied with power via an internal battery. Depending on sampling rate and number of measured variables, several thousand hours of operating time are possible. Recharge time via the magnetic connector is between two and three hours. Ideally suited for easily accessible installation situations where a short charging time is not a problem.

+ Suitable for periodic measurements



Induction

The sensor system is supplied with power via an induction coil (pickup). The pickup must be mounted ≤ 10 mm from the coupling, and supplied with 12V power, either by connecting to an R+W gateway or by using an existing 12V power supply.

+ Suitable for continuous measurement



Energy Harvesting

An energy harvester supplies the sensor system autonomously by using the energy available from the motion of the coupling (minimum speed >200 rpm). This variant is suitable for continuous measurement in horizontal installations.

+ Suitable for continuous measurement

Next level information

R+W App

View of the data in Various charts



Load collective counter

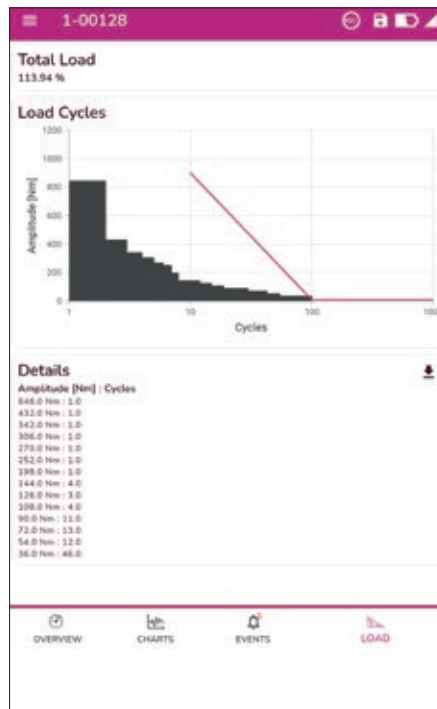

Properties

- + Configuration of the measuring amplifier and the gateway
- + Display of the measured values (incl. average and extreme values)
- + Recording, storage and export as csv file or pdf
- + Creation of individual dashboards
- + Android and iOS version
- + App language English

Threshold programming and recording



Gateway

Mobile Device Requirements

- Tablet / Smartphone with Android or iOS
- iOS version 13.0 or newer
- Android version 6.0 or newer
- Min. 30 MB free memory
- Bluetooth 4.0 or higher

Operating principle

The sensor system can be integrated into your drive train as a wireless measuring unit.

1. The system measures torque, speed, acceleration and temperature (standard) plus axial force and lateral/bending force (optional). Thus operating conditions and overloads can be precisely recorded.
2. R+W's internal electronics process the data directly and simultaneously transmits it to a connected mobile device or gateway to the machine control or a PC.
3. The sensor technology is integrated into proven R+W couplings. The mechanical properties of the coupling, such as compensation for axial, lateral and angular misalignment, and reliable torque transmission, remain unaffected.



R+W App

With the R+W App the data of the Intelligent Coupling can be displayed, recorded and exported.

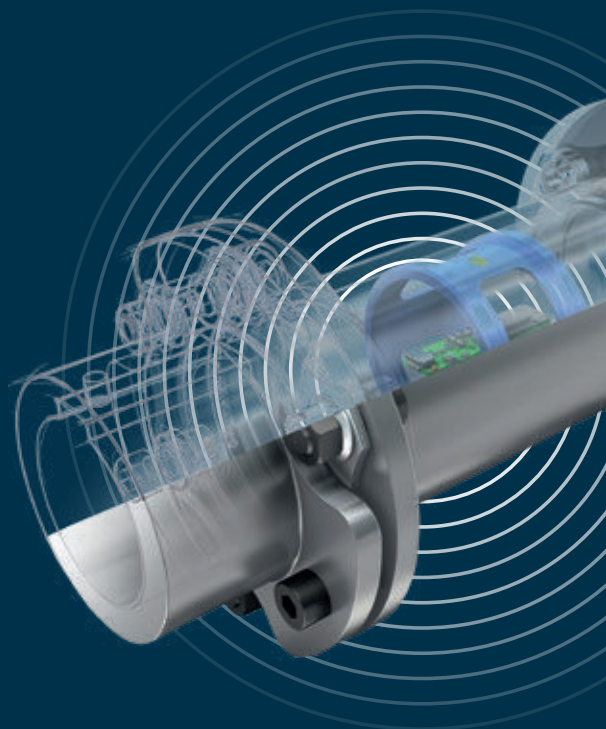

Intelligent coupling

In the standard version torque, speed, acceleration and temperature are measured.

Next level information

Measurement data provision

Data logger and event detection

Recordings can be programmed to be taken either at certain times, or when certain events occur, such as when a set threshold value is exceeded. An additional function makes measured values leading up to an event available by the software continuously recording and overwriting old data.

Technical data

Connection	PC / PLC / Cloud solution (on request)
USB-Port	USB-C (UART)
8 digital outputs	24 V
8 analog outputs	-10 to 10 V
Dimension (W x D x H)	24 × 120 × 100 mm
Range	10 m
Mounting top	hat rail (EN 50022)
Connections	up to 4 sensor couplings
Power supply	24 V







Gateway

The R+W Gateway is used for the transmission of sensor signals to downstream measuring, control or data processing systems.



Intelligent sensor couplings





Models		Features	Page
iBK2		Metal bellows coupling with clamping hub up to 300 Nm <ul style="list-style-type: none">• Integrated sensor technology• Induction only• Small installation space / easy to install• Low moment of inertia	16
iBKH		Metal bellows coupling with split clamping hub up to 300 Nm <ul style="list-style-type: none">• Integrated sensor technology• Induction only• Small installation space / easy to install• Radial mounting possible	17
iZA		Line shaft with clamping hub up to 300 Nm <ul style="list-style-type: none">• Integrated sensor technology• Installation and removal without disturbing adjacent equipment• No intermediate bearings necessary	18
iZAE		Line shaft with split clamping hub up to 225 Nm <ul style="list-style-type: none">• Integrated sensor technology• Radial mounting for easy installation and removal• No intermediate bearings necessary	19
iEZ2		Line shaft with split clamping hub up to 1,320 Nm <ul style="list-style-type: none">• Integrated sensor technology• Radial mounting for easy installation and removal• No intermediate bearings necessary	20

Product overview

Models

Features

Page

iLP2		Disc Pack coupling with key connection up to 5,200 Nm <ul style="list-style-type: none">• Integrated sensor technology• High torsional stiffness• Compensation for axial, lateral and angular misalignment• Low backlash torque transmission	21
iLP3		Disc Pack coupling with conical clamping hub up to 5,200 Nm <ul style="list-style-type: none">• Integrated sensor technology• High torsional stiffness• Compensation for axial, lateral and angular misalignment• Backlash-free torque transmission	22
iLP5		Disc pack coupling with clamping hub up to 5,200 Nm <ul style="list-style-type: none">• Integrated sensor technology• High torsional stiffness• Compensation for axial, lateral and angular misalignment• Backlash-free torque transmission• Optionally with keyway	23
iLPH		Disc pack coupling with split clamping hub up to 5,200 Nm <ul style="list-style-type: none">• Integrated sensor technology• High torsional stiffness• Compensation for axial, lateral and angular misalignment• Backlash-free torque transmission• Optionally with keyway• Simple radial assembly and disassembly	24
iFL		Flange On request	25

iBK2

Intelligent metal bellows coupling with clamping hub

15-300 Nm
Standard lengths
from 66 - 125 mm



Features

- Integrated sensor technology
- Induction only
- Small installation space / easy to install
- Low moment of inertia

Material

- **Bellows** made of highly elastic stainless steel
- **Hubs** up to series 60 made of high-strength aluminum, from series 300 made of steel

Design

Two clamping hubs with one lateral screw each.

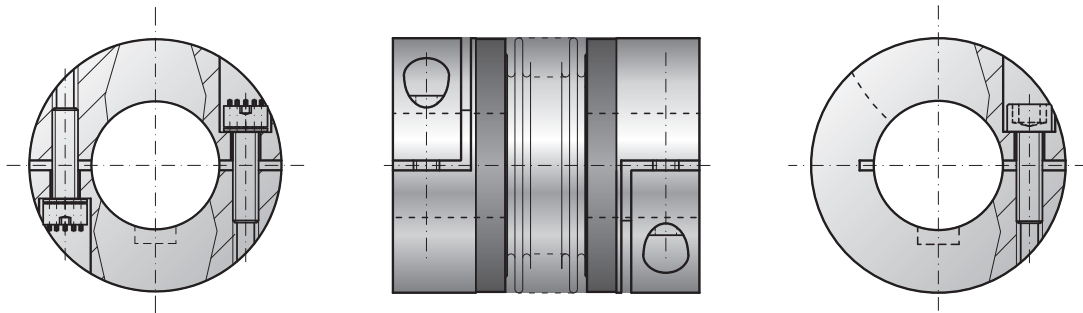

Model iBK2

Size		15	60	300
Rated torque	(Nm)	15	60	300
Max. torque	(Nm)	45	90	450
Optimum measuring range	(Nm)	2 - 45	12 - 90	14 - 450
Overall length	(mm)	66	93	125
Fit length	(mm)	22	31	43
OD Hub	(mm)	49	66	110
Bore diameter	(mm)	8 - 20	12 - 35	24 - 60

The values refer to the standard versions only.
Exact dimensions can be found on our website or in the other catalogs. Further information is available on request.
We reserve the right to make technical changes at any time.

iBKH

Intelligent metal bellows coupling with split clamping hub

15-300 Nm
Standard lengths
from 66 - 125 mm



Features

- Integrated sensor technology
- Induction only
- Small installation space / easy to mount
- Radial mounting possible

Material

- **Bellows** made of highly elastic stainless steel
- **Hubs** up to series 60 made of high-strength aluminum, from series 300 made of steel

Design

Two split clamping hubs with two lateral screws each. Clamping hub halves removable in one direction

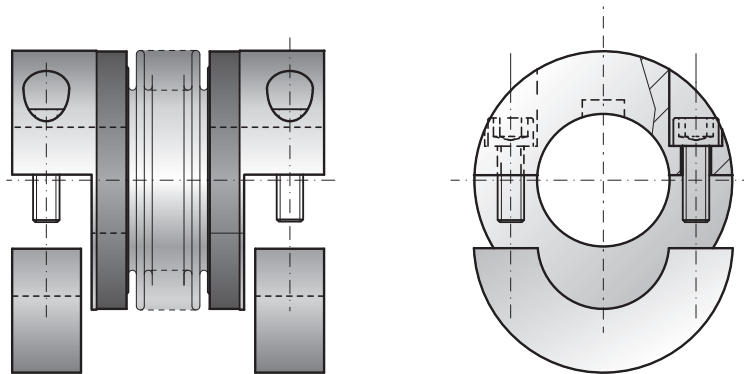

Model iBKH

Size		15	60	300
Rated torque	(Nm)	15	60	300
Max. torque	(Nm)	45	90	450
Optimum measuring range	(Nm)	2 - 45	12 - 90	14 - 450
Overall length	(mm)	66	93	125
Fit length	(mm)	22	31	43
OD Hub	(mm)	49	66	110
Bore diameter	(mm)	8 - 28	12 - 35	24 - 60

The values refer to the standard versions only.
Exact dimensions can be found on our website or in the other catalogs. Further information is available on request.
We reserve the right to make technical changes at any time.

iZA

Intelligent line shaft with clamping hub

2 - 300 Nm
Standard lengths
from 228 - 363 mm



Features

- Integrated sensor technology
- Installation and removal without disturbing adjacent equipment
- No intermediate bearings necessary

Material

- **Bellows** made of highly elastic stainless steel
- **Intermediate tube** made of aluminum
- **Hubs** up to series 60 made of high-strength aluminum, from series 150 made of steel

Design

Two clamping hubs with a lateral screw.
Intermediate tube supported inside the bellows

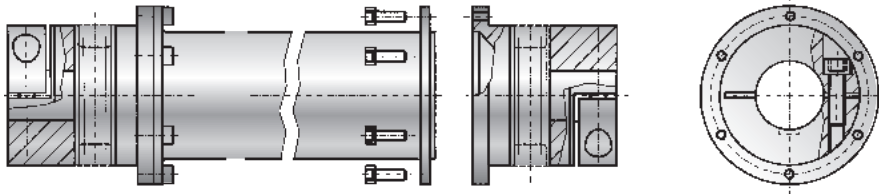

Model iZA

Size		10	30	60	150	200
Rated torque	(Nm)	10	30	60	150	200
Max. torque	(Nm)	15	45	90	225	300
Optimum measuring range	(Nm)	2 - 15	3 - 45	12 - 90	14 - 225	14 - 300
Overall length	(mm)	228	265	302	359	363
OD Hub	(mm)	40	55	66	81	90
Bore diameter	(mm)	5 - 20	10 - 28	12 - 32	19 - 42	22 - 45

The values refer to the standard versions only.
Exact dimensions can be found on our website or in the other catalogs. Further information is available on request.
We reserve the right to make technical changes at any time.

iZAE

Intelligent line shaft with split clamping hub

2 – 225 Nm
Standard lengths
from 211 – 334 mm



Features

- Integrated sensor technology
- Radial mounting for easy installation and removal
- No intermediate bearings necessary

Material

- **Bellows** made of highly elastic stainless steel
- **Intermediate tube** made of aluminum
- **Hubs** up to series 60 made of high-strength aluminum, from series 150 made of steel

Design

Two split clamping hubs with two lateral screws.
Intermediate tube supported inside the bellows.
Clamping hub halves removable in one direction.

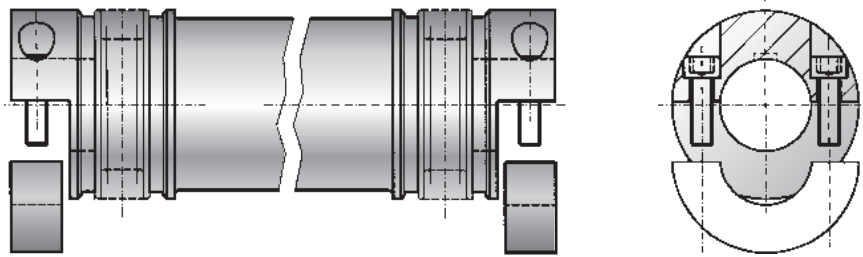

Model iZAE

Size		10	30	60	150
Rated torque	(Nm)	10	30	60	150
Max. torque	(Nm)	15	45	90	225
Optimum measuring range	(Nm)	2 - 15	3 - 45	12 - 90	14 - 225
Overall length	(mm)	211	239	278	334
OD Hub	(mm)	40	55	66	81
Bore diameter	(mm)	5 - 20	10 - 28	12 - 32	19 - 42

The values refer to the standard versions only.
Exact dimensions can be found on our website or in the other catalogs. Further information is available on request.
We reserve the right to make technical changes at any time.

iEZ2

Intelligent Line shaft with split clamping hub

2 – 1,320 Nm
Standard lengths from 206 – 396 mm



Features

- Integrated sensor technology
- Radial mounting for easy installation and removal
- No intermediate bearings necessary

Material

- **Intermediate tube** made of high-strength aluminum
- **Elastomeric ring** made of wear-resistant high-performance TPU
- **Hubs** made of high-strength aluminum

Design

Two split clamping hubs with two clamping screws in each, and concave driving jaws. Backlash free, vibration damping, electrically isolating elastomer inserts press fit into the hubs. Precision intermediate tube with a high level of straightness and lateral stiffness.

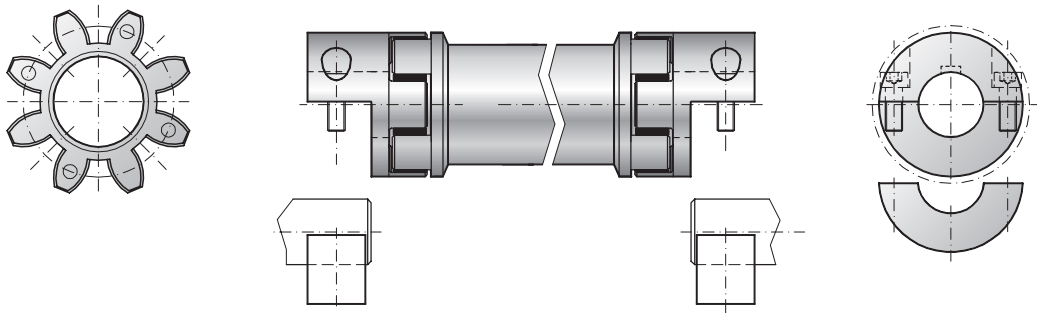

Model iEZ2

Size		10	20	60	150	300	450
Rated torque A / B	(Nm)	12,5 / 16	17 / 21	60 / 75	160 / 200	325 / 405	530 / 660
Max. torque A / B	(Nm)	25 / 32	34 / 42	120 / 150	320 / 400	650 / 810	1,060 / 1,320
Optimum measuring range A / B	(Nm)	2 - 25 / 32	3 - 34 / 42	12 - 120 / 150	14 - 320 / 400	14 - 650 / 810	24 - 1,060 / 1,320
Overall length	(mm)	206	239	283	302	360	396
OD Hub	(mm)	32	42	56	66,5	82	102
Bore diameter	(mm)	5 - 16	8 - 25	14 - 32	19 - 36	19 - 45	24 - 60

The values refer to the standard versions only.
Exact dimensions can be found on our website or in the other catalogs. Further information is available on request.
We reserve the right to make technical changes at any time.

iLP2

Intelligent disc pack coupling with key connection

14 – 5,200 Nm
Standard lengths
from 220 – 294 mm



Features

- Integrated sensor technology
- High torsional stiffness
- Compensation for axial, lateral and angular misalignment
- Low backlash torque transmission

Material

- **Disk pack** made of highly elastic spring steel
- **Hubs** made of high-strength steel

Design

Two precision machined coupling hubs and spacer mounted to the disc packs by means of high strength screws and bushings for alignment and frictional clamping of the assembly. Axial retention of the hubs on the shaft with DIN 916 set screws.

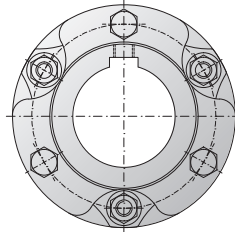
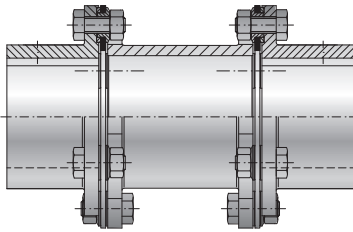

Option XL-Hub

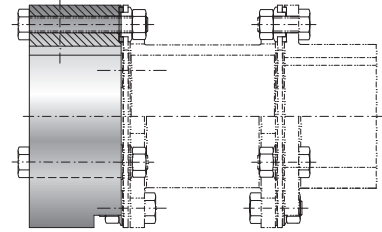

Model iLP2

Size		300	500	700	1,100	1,600	2,600
Rated torque	(Nm)	350	500	700	1,100	1,600	2,600
Max. torque	(Nm)	700	1,000	1,400	2,200	3,200	5,200
Optimum measuring range	(Nm)	14 - 700	22 - 1,000	30 - 1,400	40 - 2,200	54 - 3,200	90 - 5,200
Overall length	(mm)	220	220	242	244	290	294
OD Hub	(mm)	99	109	128	133	150	168
Bore diameter	(mm)	18 - 53	23 - 60	25 - 65	25 - 70	28 - 80	31 - 90

The values refer to the standard versions only.
Exact dimensions can be found on our website or in the other catalogs. Further information is available on request.
We reserve the right to make technical changes at any time.

iLP3

Intelligent disc pack coupling with cone clamping hub

14 – 5,200 Nm
Standard lengths
from 201 – 269 mm



Features

- Integrated sensor technology
- High torsional stiffness
- Compensation for axial, lateral and angular misalignment
- Backlash-free torque transmission

Material

- **Disk pack** made of highly elastic spring steel
- **Hubs** made of high-strength steel

Design

Two precision machined coupling hubs with conical clamping ring and spacer mounted to the disc packs by means of high strength screws and bushings for alignment and frictional clamping of the assembly.

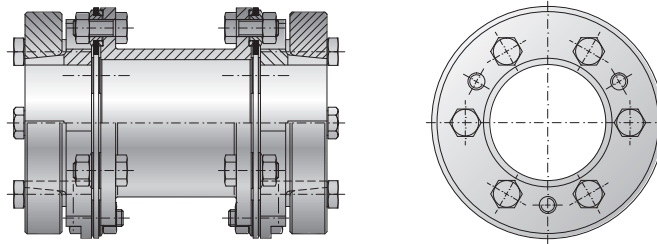

Model iLP3

Size		300	500	700	1,100	1,600	2,600
Rated torque	(Nm)	350	500	700	1,100	1,600	2,600
Max. torque	(Nm)	700	1,000	1,400	2,200	3,200	5,200
Optimum measuring range	(Nm)	14 - 700	22 - 1,000	30 - 1,400	40 - 2,200	54 - 3,200	90 - 5,200
Overall length	(mm)	201	201	219	226	252	269
OD Hub	(mm)	99	109	128	133	150	168
Bore diameter	(mm)	24 - 50	24 - 55	30 - 65	30 - 65	35 - 70	35 - 85

The values refer to the standard versions only.
Exact dimensions can be found on our website or in the other catalogs. Further information is available on request.
We reserve the right to make technical changes at any time.

iLP5

Intelligent disc pack coupling with clamping hub

14 – 5,200 Nm
Standard lengths
from 220 – 322 mm



Features

- Integrated sensor technology
- High torsional stiffness
- Compensation for axial, lateral and angular misalignment
- Backlash-free torque transmission
- Optionally with keyway

Material

- **Disk pack** made of highly elastic spring steel
- **Hubs** made of high-strength steel

Design

Two precision machined split clamping hubs and spacer mounted to the disc packs by means of high strength screws and bushings for alignment and frictional clamping of the assembly.

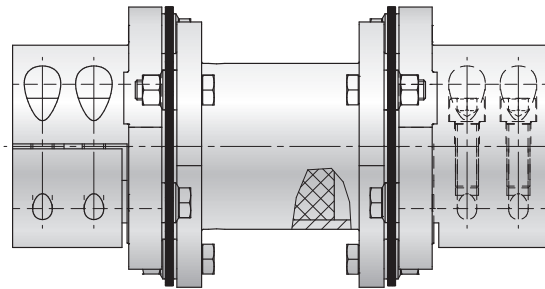

Model iLP5

Size		300	500	700	1,100	1,600	2,600
Rated torque	(Nm)	350	500	700	1,100	1,600	2,600
Max. torque	(Nm)	700	1,000	1,400	2,200	3,200	5,200
Optimum measuring range	(Nm)	14 - 700	22 - 1,000	30 - 1,400	40 - 2,200	54 - 3,200	90 - 5,200
Overall length	(mm)	220	238	260	278	310	322
OD Hub	(mm)	99	109	128	133	150	168
Bore diameter	(mm)	18 - 48	23 - 50	25 - 58	25 - 60	28 - 64	31 - 75

The values refer to the standard versions only.
Exact dimensions can be found on our website or in the other catalogs. Further information is available on request.
We reserve the right to make technical changes at any time.



Intelligent disc pack coupling with split clamping hub

14 – 5,200 Nm
Standard lengths from 220 – 322 mm



Features

- Integrated sensor technology
- High torsional stiffness
- Compensation for axial, lateral and angular misalignment
- Backlash-free torque transmission
- Optionally with keyway
- Simple radial assembly and disassembly

Material

- **Disk pack** made of highly elastic spring steel
- **Hubs** made of high-strength steel

Design

Two precision machined fully split clamping hubs and spacer mounted to the disc packs by means of high strength screws and bushings for alignment and frictional clamping of the assembly.

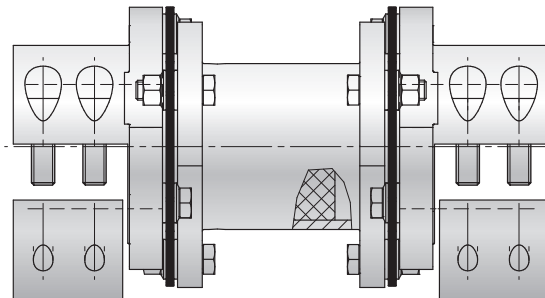

Model iLPH

Size		300	500	700	1,100	1,600	2,600
Rated torque	(Nm)	350	500	700	1,100	1,600	2,600
Max. torque	(Nm)	700	1,000	1,400	2,200	3,200	5,200
Optimum measuring range	(Nm)	14 - 700	22 - 1,000	30 - 1,400	40 - 2,200	54 - 3,200	90 - 5,200
Overall length	(mm)	220	238	260	278	310	322
OD Hub	(mm)	99	109	128	133	150	168
Bore diameter	(mm)	18 - 48	23 - 50	25 - 58	25 - 60	28 - 64	31 - 75

The values refer to the standard versions only.
Exact dimensions can be found on our website or in the other catalogs. Further information is available on request.
We reserve the right to make technical changes at any time.

iFL

Intelligent Flange

Special solution
on demand

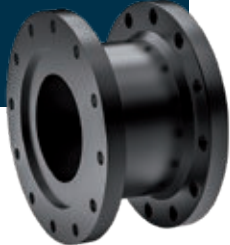

Features

- Suitable for connection to cardan shafts
- Connection to customer specific hole patterns
- Rigid connection for recording the measured values

iSTF

Special solution
on demand



Features

- Intelligent flange with overload protection function
- Suitable for connection to cardan shafts
- Connection to customer specific hole patterns
- Rigid connection for recording the measured values

Mix & Match of the intelligent sensor coupling

The intelligent coupling with built-in sensor technology offers a flexible and tailor-made solution for various different areas of application. Due to the possibility of mix & match, different components can be selected and combined. Thus, the coupling is adapted to your specific requirement. With this approach you can increase your efficiency, reduce costs and improve the quality of your processes.



① **Select measured variables**

By default, the sensor coupling measures torque, speed, acceleration and temperature. In addition, axial or lateral force can be measured.

② **Selecting the power supply**

The selection of the suitable power supply depends on your individual application, and could be a battery, induction coil (pickup) or energy harvester. More detailed information can be found on page 10.

③ **Select transmission type**

The transmission of the measurement data can be freely selected. Either the data is displayed and exported directly via a mobile device or it is connected directly to your machine control system via a gateway. Optionally, the data can be transferred directly to a cloud solution.

④ **Selecting the coupling for the area of application**

With regard to installation space, accessibility, application parameters, and connections the right coupling type must be selected for your application.

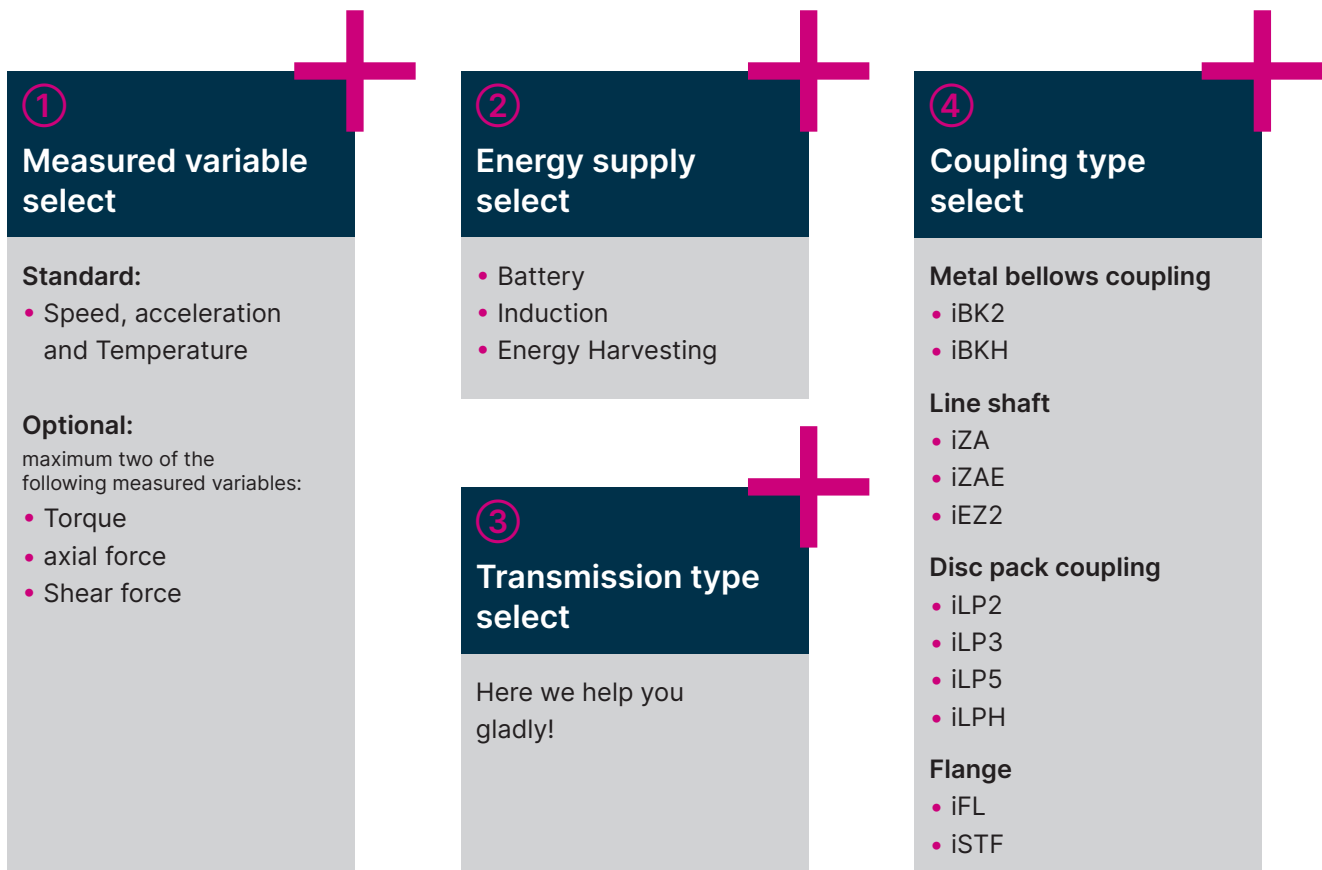

For further information and details please refer to our catalog for precision or industrial couplings.

Contact us at any time!
Our experts will be happy to advise you.

You can reach us by phone at
+49 9372 9864 46 or by mail to
sensor@rw-kupplungen.de.

THE INTELLIGENT COUPLING.



R+W Antriebselemente GmbH

Hattsteinstraße 4
63939 Würth am Main
Germany

Phone: +49 9372-9864-0

info@rw-kupplungen.de

www.rw-couplings.com