

IMA

INTEGRATED MOTOR ROD-STYLE ACTUATOR

ENDURANCE TECHNOLOGYSM
A Tolomatic Design Principle
Patented



LINEAR SOLUTIONS MADE EASY

The longest lasting, high-force integrated actuator on the market!

The IMA is a compact, durable, high force rod-style actuator. The IMA integrates a servo motor into a ball or roller screw-driven actuator to provide efficient high force in a compact lightweight design envelope. Our patented* design allows for easy re-lubrication without disassembly for extremely long service life.

*U.S. PATENT NO. 8,196,484

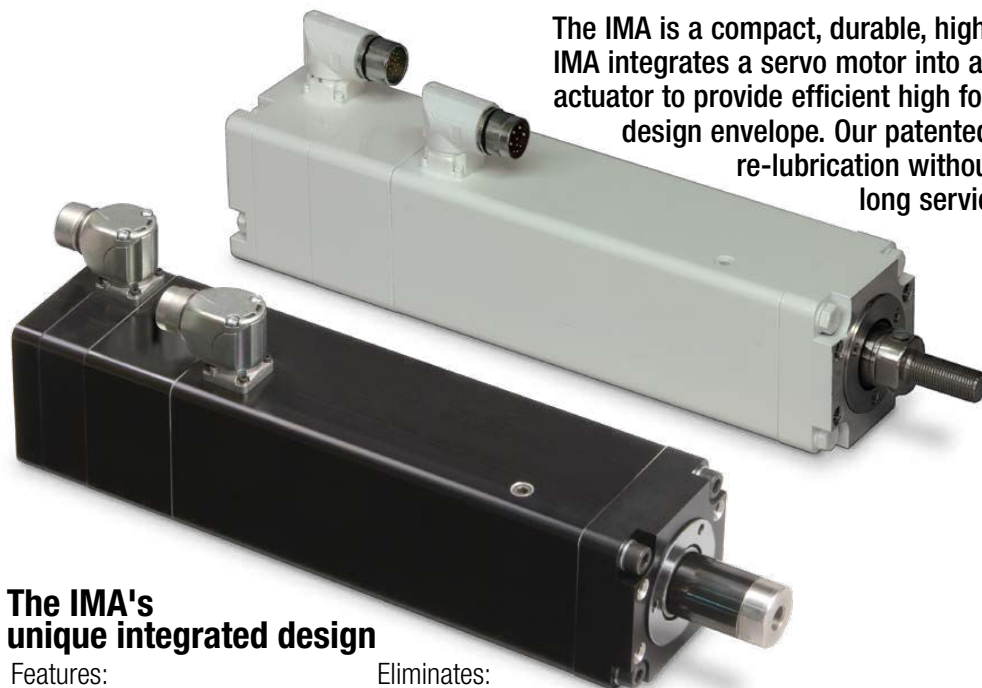

The IMA's unique integrated design

Features:

- Compact, lightweight design
- Long life
- High force
- High positional accuracy
- High efficiency
- Proven performance
- Ratings for extreme environments
- Compatibility
- Low inertia

Eliminates:

- Couplers
- Adapters
- Belts
- Gears
- Unneeded assembly labor
- Forced air or water cooling
- Hydraulic systems
- Pneumatic systems
- Need for multiple vendors

**PATENTED
SCREW
LUBRICATION
SYSTEM FOR
EXTENDED
SERVICE LIFE**

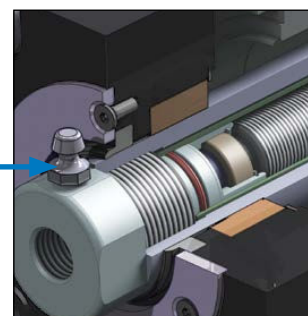

TOLOMATIC'S ELECTRIC ROD-STYLE ACTUATORS

	ERD	RSH	RSA	RSX	GSA	Combined Actuator & Motor	
						IMA	IMAS
	Rod-Style Actuator	Hygienic Rod-Style Actuator	Rod-Style Actuator	High Force Rod-Style Actuator	Guided Rod-Style Actuator	Integrated Servo Actuator	Hygienic Integrated Servo Actuator
Force up to:	2 kN (500 lbf)	35 kN (7,900 lbf)	58 kN (13,000 lbf)	294 kN (66,000 lbf)	18 kN (4,100 lbf)	36 kN (8,000 lbf)	11 kN (2,500 lbf)
Speed up to:	1.0 m/sec (40 in/sec)	0.5 m/sec (20 in/sec)	3.1 m/sec (120 in/sec)	0.8 m/sec (30 in/sec)	3.1 m/sec (120 in/sec)	1.3 m/sec (50 in/sec)	0.5 m/sec (20 in/sec)
Stroke Length up to:	0.6 m (24 in)	1.2 m (48 in)	1.5 m (60 in)	1.5 m (59 in)	0.9 m (36 in)	0.5 m (18 in)	0.5 m (18 in)
Screw/Nut Type	Solid & Ball	Ball & Roller	Solid, Ball & Roller	Ball & Roller	Solid, Ball & Roller	Ball & Roller	Ball & Roller

For complete information see www.tolomatic.com or literature number:

Literature Number: 2190-4000 2100-4010 3600-4233 2171-4001 3600-4231 2700-4000 2700-4014

(Not all models deliver maximum values listed, i.e.: Maximum thrust may not be available with maximum speed)

IMA - Integrated Motor Actuator

IMA Applications

Press Fitting System

- High Force
- Long Life



Valve / Process Control

- Efficient
- Accurate Positioning
- Quick Response

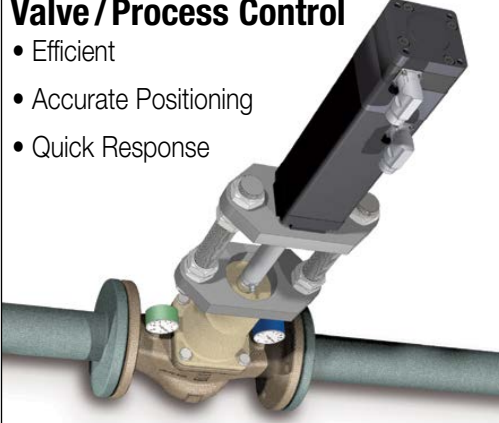

CONTENTS

- What is the IMA? 2
- IMA Applications 3
- IMA Features 4
- IMA Specs & Performance 6-10
- IMA Dimensions 11-14
- Application Data Worksheet 17
- Selection Guidelines 16
- Ordering 19

Spot Welding

- Compact, Lightweight
- Repeatable, High Force



Fluid Dispensing

- Repeatable Force
- Smooth Velocity

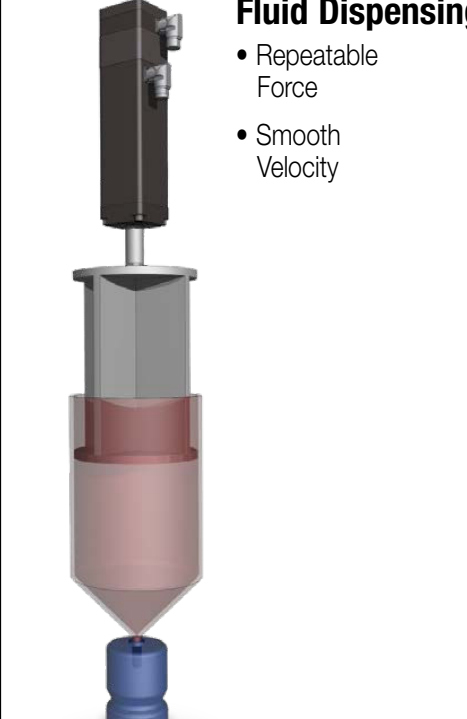

More Applications:

- Aerospace
- Animation
- Assembly
- Automated assembly
- Automatic tool changers
- Automotive
- Clamping
- Converting
- Conveyors
- Cycle testing
- Fillers
- Formers
- Hydraulic replacement
- Laser positioning
- Machine tools
- Material handling systems
- Medical equipment
- Military
- Molding
- Motion simulators
- Open / close doors
- Packaging equipment
- Parts clamping
- Patient lifts
- Pick & place
- Pneumatic replacement
- Precision grinders
- Product test simulations
- Riveting / fastening / joining
- Robot manipulator arms
- Sawmill equipment
- Semiconductor
- Stamping
- Table positioning
- Tension control
- Test stands
- Tube bending
- Volumetric pumps
- Water jet control
- Wave generation
- Web guidance
- Welding
- Wire winding

IMA INTEGRATED MOTOR ACTUATOR

The IMA is a compact, durable, high force rod-style actuator with an IP65 rating. The IMA integrates a servo motor into a ball or roller screw-driven actuator to provide efficient high force in a compact lightweight design envelope. Our patented design allows for easy re-lubrication without disassembly for extremely long service life. Built-to-order in stroke lengths up to 450 mm (18") with your choice of screw technology.

Tolomatic™... MAXIMUM DURABILITY
EXCELLENCE IN MOTION

ENDURANCE TECHNOLOGYSM

A Tolomatic Design Principle

ROBOT & DRIVE/CONTROLLER COMPATIBILITY

- Compatible feedback, connector(s) and wiring to match the following robot & drive/controller manufacturers:
- ABB Robot* Techniques FM & NT • Nachi Robot*
- Aerotech BM* • Fanuc Robot* • Omron*
- Allen Bradley MP & VP • Kawasaki Robot* • Parker MPP*
- B&R 8LS* • Kollmorgen AKM* • Schneider Electric SH*
- Baldor BSM • Kuka Robot* • SEW CMP*
- Beckhoff AM8* • Lenze MCA • Siemens 1F*
- Bosch Rexroth MSK • Motoman / Yaskawa Robot* • Stober*
- Nidec/Control Robot* *Consult Tolomatic for lead time
- Tolomatic standard connector, wiring and flying lead cable can be used to integrate with servo drive manufacturers such as:
- AMC • Copley • Elmo • + Others
- STAGGERED CONNECTORS for convenient installation

MULTIPLE SCREW TECHNOLOGIES

YOU CAN CHOOSE:

- Ball screws offer efficiency at a cost effective price
- Roller screws provide the highest force and life ratings available



HIGH POSITIONAL ACCURACY

MAX. SCREW ACCURACY

Roller Nut $\pm 0.0004"/ft.$ $\pm 0.0102mm/300mm$
Ball Nut $\pm 0.0009"/ft.$ $\pm 0.023mm/300mm$

INTERNAL BUMPERS

- Bumpers protect the screw and nut assembly from damage at end of stroke

REPLACEABLE ROD WIPER

- Prevents contaminants from entering the actuator for extended life

GREASE PORT

- Screw re-lubrication system provides extended screw service life
- Convenient lubrication without disassembly (IMA22 is lubed for life and does not include grease port)

INTEGRAL MOUNTING

- Four metric threaded holes on front face are available for direct mounting or addition of customized options

THREADED ROD END

- Zinc plated alloy steel construction for corrosion resistance
- Provides a common interface to multiple rod end options

THRUST TUBE

- Steel thrust tube supports extremely high force capabilities
- Salt bath nitride treatment provides excellent corrosion resistance, surface hardness and is very resistant to adherence of weld slag, water and other potential contaminant

LIGHTWEIGHT ALUMINUM DESIGN

- Black anodized extrusion design is optimized for rigidity and strength

SMOOTH BODY DESIGN

- Eliminates potential contaminant collection points

HIGH RESOLUTION FEEDBACK

YOU CAN CHOOSE:

- Incremental encoder
- Multi-turn absolute encoder, Hiperface, Hiperface DSL, EnDat 2.2
- Resolver

HIGH FORCE ANGULAR CONTACT BEARINGS

- Provides complete support of screw and protects the feedback device from linear forces

MULTIPLE MOTOR WINDINGS

YOU CAN CHOOSE:

- 230V or 460V rated windings potted directly into actuator housing
- Skewed motor windings provide minimal torque ripple for smooth linear motion
- Integral thermal switch for over temperature protection
- 1 stack motor (MV21-230V & MV41-460V) available for the IMA22 & IMA33, allows strokes between 3 and 6" providing the force needed for many applications in a more compact, lighter weight packages

OPTIONS (SEE IMA EXTENDED CATALOG FOR MORE IMA OPTIONS)

MOUNTING

- Front Face - Standard
- Side Mounting Holes, 2 sides & bottom (no photo)
- Mounting Plates
- Rear Clevis
- Front Flange
- Trunnion, Rear or Front

ROD END

- Internal Thread - Standard
- External Threads
- Clevis
- Spherical Eye
- Alignment Coupler

BRAKE

- 24V Spring held / electronically released

IP67 • For protection against water and dust ingress

CABLES

- Signal Cable (5 & 10 m)
- Power Cable (5 & 10 m)

ARO • Anti-Rotate



IMA - Integrated Motor Actuator

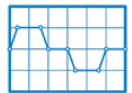

Performance & Mechanical Specifications:

Series	Nut/ Screw	Screw Lead	Motor Stack ¹	Cont. Thrust	Peak Thrust	Dynamic Load Rating	Lead Accuracy	Max. Velocity	Base Inertia ²	Inertia per unit of Stroke	Break- away Torque	Nominal Back Drive Force ³
		mm		kN	kN	kN	mm/300mm	mm/sec	kg-cm ²	kg-cm ² / mm	N-m	N
IMA22	BN05	5	1	0.89	1.45	5.74	0.052	356	0.897	0.0036	0.34	218
			3	1.45	1.45			356	1.482			
	BN10	10	1	0.45	1.36	4.40	0.052	711	0.901	0.0029	0.34	109
			3	0.80	1.45			711	1.487			
IMA33	BN05	5	1	1.62	4.45	8.72	0.052	305	2.723	0.0078	0.54	347
			3	4.00	4.45			292	4.825			
	BN10	10	1	0.81	2.44	5.43	0.052	610	2.737	0.0093	0.54	173
			3	2.00	4.00			584	4.838			
	BN20	20	1	0.41	1.23	11.39	0.100	1,217	2.908	0.0359	0.54	89
			3	1.00	3.00			1,167	5.010			
	RN04	4	1	2.00	6.01	41.10	0.010	244	2.727	0.0103	0.60	434
			3	4.76	11.12			234	4.829			
	RN05	5	1	1.56	4.67	45.82	0.010	305	2.729	0.0105	0.60	347
			3	3.78	11.34			292	4.831			
	RN10	10	1	0.78	2.34	45.82	0.010	610	2.747	0.0121	0.60	173
			3	1.89	5.69			584	4.848			
IMA44	BN05	5	3	7.78	10.45	17.97	0.023	267	9.689	0.0530	0.63	405
	BN10	10	3	3.89	11.03	15.03	0.023	533	9.719	0.0549	0.63	205
	BN25	25	3	1.56	4.67	11.30	0.100	1,334	9.933	0.0683	0.63	80
	RN04	4	3	9.34	18.46	56.94	0.010	234	9.609	0.0285	0.70	507
	RN05	5	3	7.34	17.13	56.94	0.010	292	9.614	0.0288	0.70	405
	RN10	10	3	3.67	11.03	56.94	0.010	584	9.648	0.0309	0.70	205
IMA55	BN05	5	3	13.12	17.39	29.89	0.023	167	75.240	0.4462	1.06	681
	BN10	10	3	6.58	16.41	33.27	0.023	333	75.340	0.4501	1.06	343
	BN20	20	3	3.28	8.23	24.60	0.023	667	75.720	0.4664	1.06	169
	RN05	5	3	12.23	35.81	106.31	0.010	201	74.720	0.3234	1.16	676
RN10	10	3	6.14	17.93	106.31	0.010	399	74.830	0.3279	1.16	338	

		in		lbf	lbf	lbf	in/ft	in/sec	lb-in ²	lb-in ² / in	in-lb	lbf
IMA22	BN05	0.197	1	200	325	1,290	0.0021	14.0	0.306	0.0012	3.0	49
			3	325	325			14.0	0.506			
	BN10	0.394	1	102	305	990	0.0021	28.0	0.308	0.0010	3.0	25
			3	180	325			28.0	0.508			
IMA33	BN05	0.197	1	365	1,000	1,960	0.0021	12.0	0.931	0.0027	4.8	78
			3	900	1,000			11.5	1.649			
	BN10	0.394	1	183	549	1,220	0.0021	24.0	0.935	0.0032	4.8	39
			3	450	900			23.0	1.653			
	BN20	0.788	1	92	276	2,560	0.0040	47.9	0.994	0.0123	4.8	20
			3	225	675			45.9	1.712			
	RN04	0.157	1	450	1,350	9,240	0.0004	9.6	0.932	0.0035	5.3	98
			3	1,070	2,500			9.2	1.650			
	RN05	0.197	1	350	1,050	10,300	0.0004	12.0	0.933	0.0036	5.3	78
			3	850	2,550			11.5	1.651			
	RN10	0.394	1	175	525	10,300	0.0004	24.0	0.939	0.0041	5.3	39
			3	425	1,280			23.0	1.657			
IMA44	BN05	0.197	3	1,750	2,350	4,040	0.0009	11.5	3.311	0.0181	5.6	91
	BN10	0.394	3	875	2,480	3,380	0.0009	23.0	3.321	0.0188	5.6	46
	BN25	0.985	3	350	1,050	2,540	0.0040	52.5	3.394	0.0233	5.6	18
	RN04	0.157	3	2,100	4,150	12,800	0.0004	9.2	3.284	0.0098	6.2	114
	RN05	0.197	3	1,650	3,850	12,800	0.0004	11.5	3.285	0.0098	6.2	91
	RN10	0.394	3	825	2,480	12,800	0.0004	23.0	3.297	0.0106	6.2	46
IMA55	BN05	0.197	3	2,950	3,910	6,720	0.0009	7.9	25.710	0.1525	9.4	153
	BN10	0.394	3	1,480	3,690	7,480	0.0009	15.7	25.750	0.1538	9.4	77
	BN20	0.788	3	738	1,850	5,530	0.0009	26.2	25.880	0.1594	9.4	38
	RN05	0.197	3	2,750	8,050	23,900	0.0004	7.9	25.530	0.1105	10.3	152
RN10	0.394	3	1,380	4,030	23,900	0.0004	15.7	25.570	0.1120	10.3	76	

Performance data was validated using an aluminum face mount plate:
 IMA22 (8.25" x 7.0" x 0.7");
 IMA33 (8.25" x 7.0" x 0.7");
 IMA44 (9.0" x 9.0" x 0.7");
 IMA55 (9.0" x 9.0" x 1.0")
 Ambient Temp. = 77°F (25°C);
 Elevation < 3281' (1,000 m);
 Drive specifications: Sinusoidal
 Commutation and PWM
 Voltage Source

¹ Stack winding MV21 / 41
 3 Stack winding MV23 / 43
²Value given is for a zero stroke
 actuator † To be determined,
 visit www.tolomatic.com for
 up-to-date information

³In all vertical application an
 unpowered IMA will require
 a brake to maintain position.
 Tolomatic recommends that
 the nominal back drive force
 specification be used for
 reference only. Back drive
 force is subject to change
 throughout the life of the
 actuator, due to mechanical
 break in, ambient temperature,
 and duty cycle variation.

Reference Only

Back drive force is subject to
 change throughout the life of
 the actuator, due to mechanical
 break in, ambient temperature,
 and duty cycle variation.

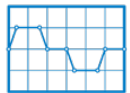

Performance & Mechanical Specifications:

		IMA22 (1 STACK, MV21/41)	IMA22 (3 STACK, MV23/43)	IMA33 (1 STACK, MV21/41)	IMA33 (3 STACK, MV23/43)	IMA44	IMA55
Face Size	mm	63.5	63.5	83	83	110	142
	in	2.5	2.5	3.3	3.3	4.4	5.6
Stroke	mm	76.2 to 304.8	152.4 to 304.8	76.2 to 457.2	152.4 to 457.2	152.4 to 457.2	152.4 to 457.2
	in	3.0 to 12.0	6.0 to 12.0	3.0 to 18.0	6.0 to 18.0	6.0 to 18.0	6.0 to 18.0
**Base Weight	kg	2.4	2.9	5.2	6.4	13	24.8
	lb	5.3	6.4	11.4	14.1	28.6	54.5
Weight per unit of Stroke	kg/mm	0.0073	0.0073	0.0118	0.0118	0.0197	0.03771
	lb/in	0.2428	0.2428	0.6603	0.6603	1.1035	2.1115
Screw Lead	BN	in = 0.004		mm = 0.1			
Backlash	RN	in = 0.0020		mm = 0.051			
Temp Range	°C	Standard: 10 to 40; Extended: -20 to 60 (Contact Tolomatic if operation in the Extended Range is required)					
	°F	Standard: 50 to 104; Extended: -4 to 140 (Contact Tolomatic if operation in the Extended Range is required)					
IP Rating		Standard IP65, Optional IP67 (Static)					
Rel. Humidity (non-condensing)		5 to 90%					
Shock		20g peak, 6 msec duration					
Vibration		2.5g 30....2,000 Hz					

*In vertical applications an unpowered IMA will require a brake to maintain position if the load on the actuator exceeds this value

**Value given is for a zero stroke actuator

Motor Specifications:

		IMA22				IMA33				IMA44		IMA55	
Winding/Motor Voltage		MV21	MV41	MV23	MV43	MV21	MV41	MV23	MV43	MV23	MV43	MV23	MV43
Torque Constant (Kt)	N-m/A Peak	0.37	0.74	0.49	0.93	0.61	1.21	0.62	1.21	0.61	1.20	0.76	1.51
	in-lb/A Peak	3.3	6.6	4.3	8.2	5.4	10.7	5.5	10.7	5.4	10.6	6.7	13.4
Voltage Constant (Ke)	V/Krpm Peak	51.0	102.0	61.0	122.0	81.0	160.0	79.8	154.0	78.1	153.1	100.0	201.0
Continuous Stall Torque	N-m	0.85		1.50		1.80		4.40		8.50		12.70	
	in-lb	7.5		13.3		16.0		39.0		75.0		112.0	
Continuous Stall Current	ARMS	1.60	0.80	2.20	1.15	2.10	1.10	5.00	2.50	9.70	5.00	11.80	5.90
Peak Torque	N-m	2.54		4.50		5.40		13.20		25.40		38.00	
	in-lb	22.5		39.9		48.0		117.0		225.0		336.0	
Peak Current	ARMS	4.8	2.4	6.6	3.5	6.3	3.3	15.0	7.5	29.1	15.0	29.5	14.8
Resistance	Ohms	18.10	72.40	7.10	28.30	10.00	40.10	2.07	8.30	0.58	2.32	0.57	2.93
Inductance	mH	10.7	42.0	4.5	18.0	13.6	54.1	3.8	15.0	2.8	11.5	1.4	5.8
Bus Voltage	VRMS	230	460	230	460	230	460	230	460	230	460	230	460
Speed @ Rated V	RPM	4,264				3,650		3,500		3,500		2,400	
Number of Poles		8											

RoHs Compliant Components; c us

Performance data was validated using an aluminum face mount plate: IMA22/33 (8.25" x 7.0" x 0.7"); IMA44 (9.0" x 9.0" x 0.7"); IMA55 (9.0" x 9.0" x 1.0"); Ambient Temperature = 77°F (25°C); Elevation < 3281' (1,000 m); Drive specifications: Sinusoidal Commutation and PWM Voltage Source

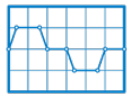

CRITICAL SPEED

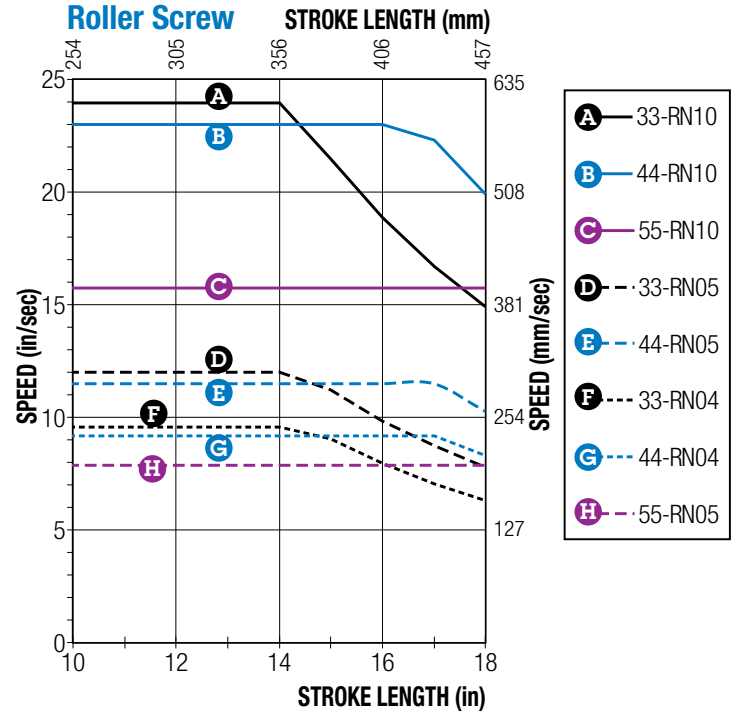
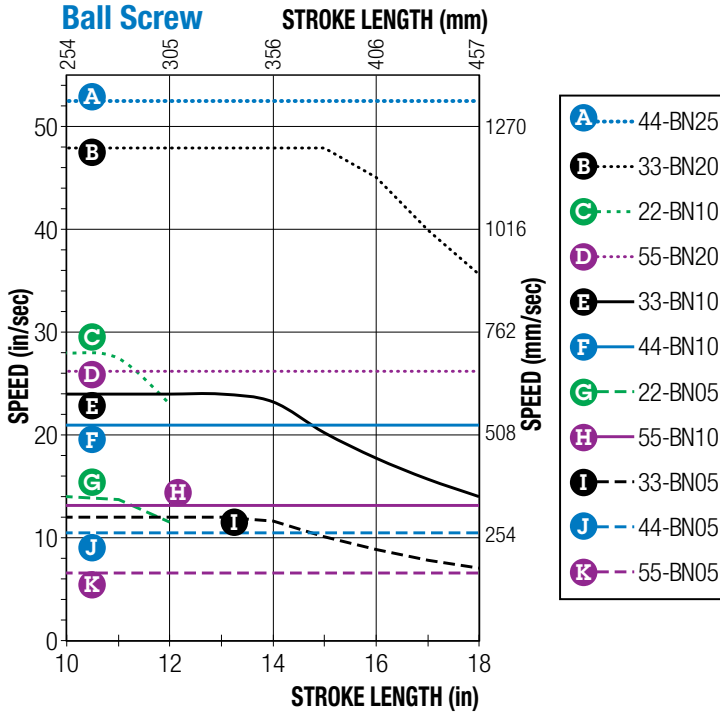

SCREW BUCKLING LOAD

Ball Screw

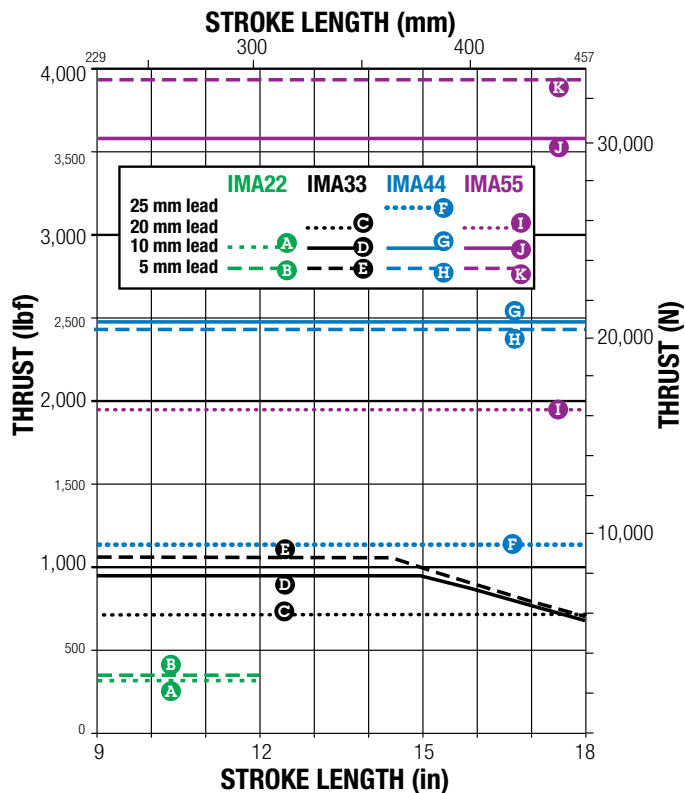

Roller Screw

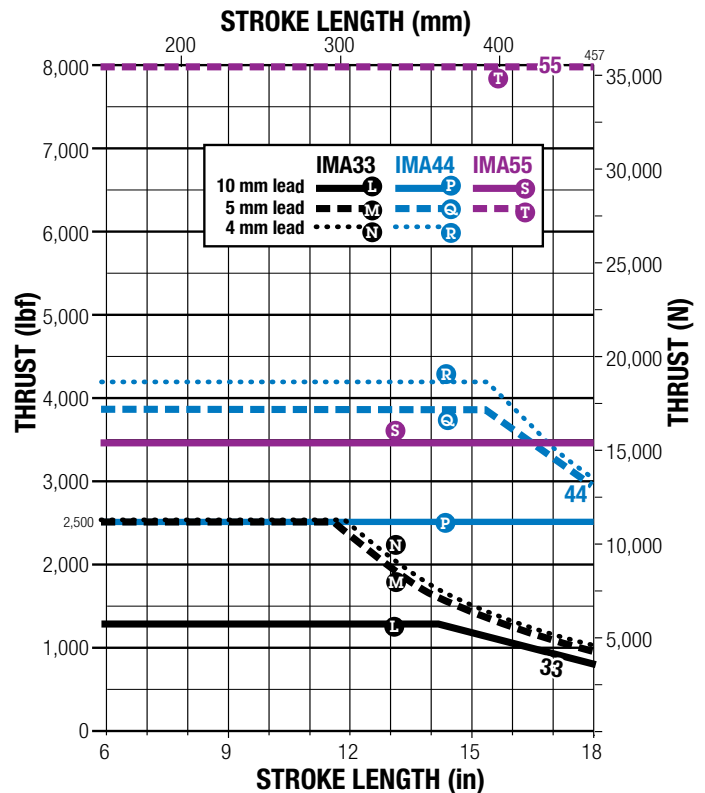

All curves represent properly lubricated and maintained actuators.

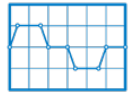

LIFE

BALL SCREW

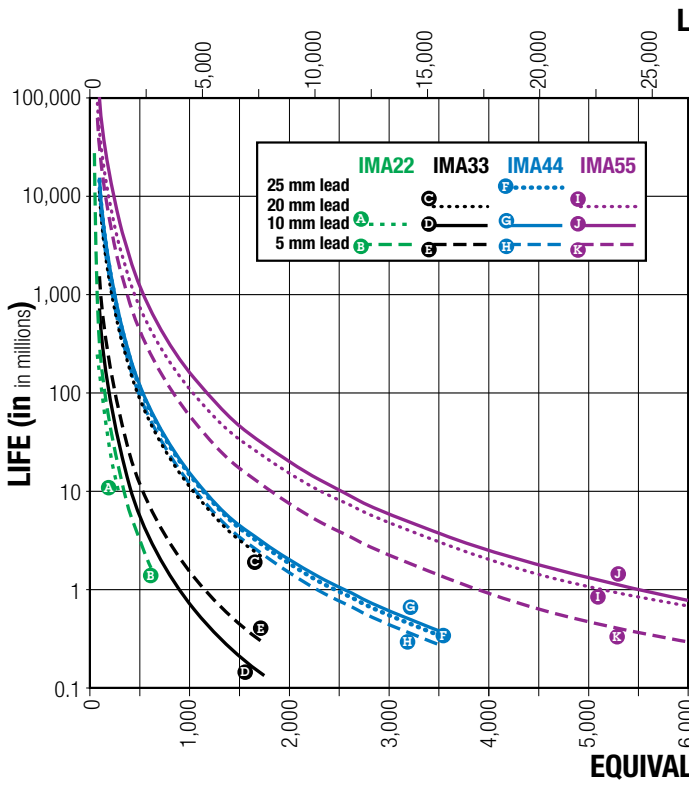

ROLLER SCREW

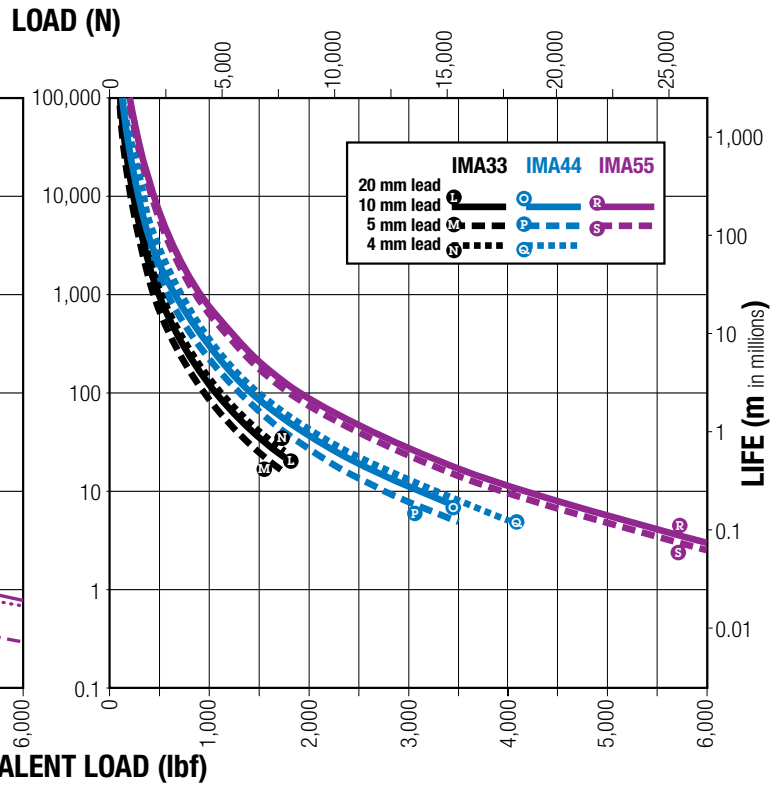

All curves represent properly lubricated and maintained actuators.

NOTE: The L_{10} expected life of a ball screw linear actuator is expressed as the linear travel distance that 90% of properly maintained ball screw manufactured are expected to meet or exceed. This is not a guarantee and this graph should be used for estimation purposes only.

The underlying formula that defines this value is:

$$L_{10} = \left(\frac{C}{P_e} \right)^3 \cdot \ell \equiv$$

L_{10} Travel life in millions of units (in or mm), where:

- C** = Dynamic load rating (lbf) or (N)
- P_e** = Equivalent load (lbf) or (N)
- If load is constant across all movements then:
actual load = equivalent load
- ℓ = Screw lead (in/rev) (mm/rev)

Use the "Equivalent Load" calculation below, when the load is not constant throughout the entire stroke. In cases where there is only minor variation in loading, use greatest load for life calculations.

$$\text{Where: } P_e = \sqrt[3]{\frac{L_1(P_1)^3 + L_2(P_2)^3 + L_3(P_3)^3 + L_n(P_n)^3}{L}}$$

- P_e** = Equivalent load (lbf) or (N)
- P_n** = Each increment at different load (lbf) or (N)
- L** = Total distanced traveled per cycle (extend + retract stroke)
[$L = L_1 + L_2 + L_3 + L_n$]
- L_n** = Each increment of stroke at different load (in) or (mm)

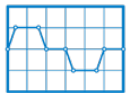

RE-LUBRICATION RECOMMENDATION:

IMA33, IMA44, IMA55: IMA Lubrication requirements for electric actuators depend on the motion cycle (velocity, force, duty cycle), type of application, ambient temperature, environmental surrounding and various other factors.

For many general purpose applications, Tolomatic ball screw actuators are typically considered lubricated for life unless otherwise specified, such as those actuator models outfitted with a re-lubrication feature. For roller screw or ball screw actuators outfitted with a re-lubrication feature, Tolomatic recommends to re-lubricate the actuator at least once per year or every 1,000,000 cycles, whichever comes first, to maximize service life. For more demanding applications such as pressing, high frequency or other highly stressed applications, the re-lubrication interval for these actuators will vary and will need to be more frequent. In these demand-

ing applications, it is recommended to execute at least 5 full stroke moves every 5,000 cycles of operation (or more frequent if possible) to re-distribute the grease within the actuator.

Re-lubricate with Tolomatic Grease #2744-9099 into the grease zerk located on the rod end.

	Quantity	
IMA33	2.5 + [0.010 x L (mm)]	g
IMA44	4.8 + [0.010 x L (mm)]	g
IMA55	6.6 + [0.019 x L (mm)]	g
IMA33	0.09 + [0.009 x L (in)]	oz
IMA44	0.17 + [0.009 x L (in)]	oz
IMA55	0.23 + [0.017 x L (in)]	oz

L=stroke length (mm or in)

⚠ In some applications oil may leak from the grease zerk. In contamination sensitive applications replace grease zerk with plug.

SIDE LOAD CONSIDERATIONS

The IMA integrated motor actuator is not meant to be used in applications where side loading occurs. Loads must be guided and supported. Loads should be aligned with the line of motion of the thrust rod. Side loading will affect the life of the actuator.



IMA SIDE LOAD SPECIFICATIONS

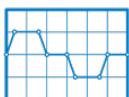
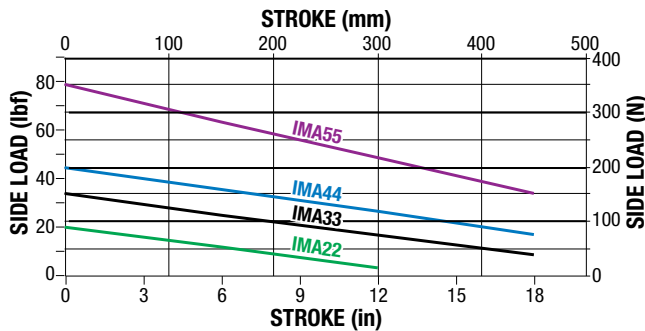

USE THE TOLOMATIC SIZING AND SELECTION SOFTWARE AVAILABLE ON-LINE AT www.tolomatic.com OR...

CALL TOLOMATIC AT 1-800-328-2174.

We will provide any assistance needed to determine the proper actuator for the job.

BRAKE CONSIDERATIONS

In all vertical application an un-powered IMA will require a brake to maintain position. Tolomatic recommends that the nominal back drive force specification (listed on page IMA_8) be used for reference only. Back drive force is subject to change throughout the life of the actuator, due to mechanical break in, ambient temperature, and duty cycle variation.

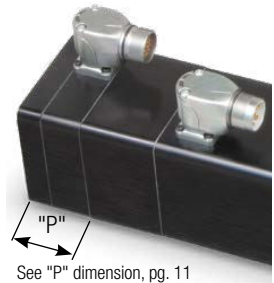

A brake can be used with the actuator to keep it from backdriving, typically in vertical applications. A brake may be used for safety reasons or for energy savings allowing the actuator to hold position when un-powered. See page IMA_23 for ordering information.

NOTE: The optional Spring-Applied / Electronically-Released Brake requires 24V power. Input current rating:

- IMA22 - 0.35 Amps;
- IMA33 - 0.43 Amps;
- IMA44 - 0.67 Amps;
- IMA55 - 0.66 Amps.

Brake Specifications:

	SERIES	IMA22	IMA33	IMA44	IMA55
ROTOR INERTIA	gm-cm ²	19	73	239	214
	oz-in ²	0.104	0.400	1.307	1.171
HOLDING TORQUE	N-m	1.6	4.0	9.0	16.4
	in-lb	14	35	89	145
CURRENT	Amp	0.35	0.43	0.67	0.66
ENGAGE TIME	mSec	75	40	25	15
DISENGAGE TIME	mSec	20	50	35	25
VOLTAGE	Vdc	24			



Dimensions: All Sizes

DIMENSIONS

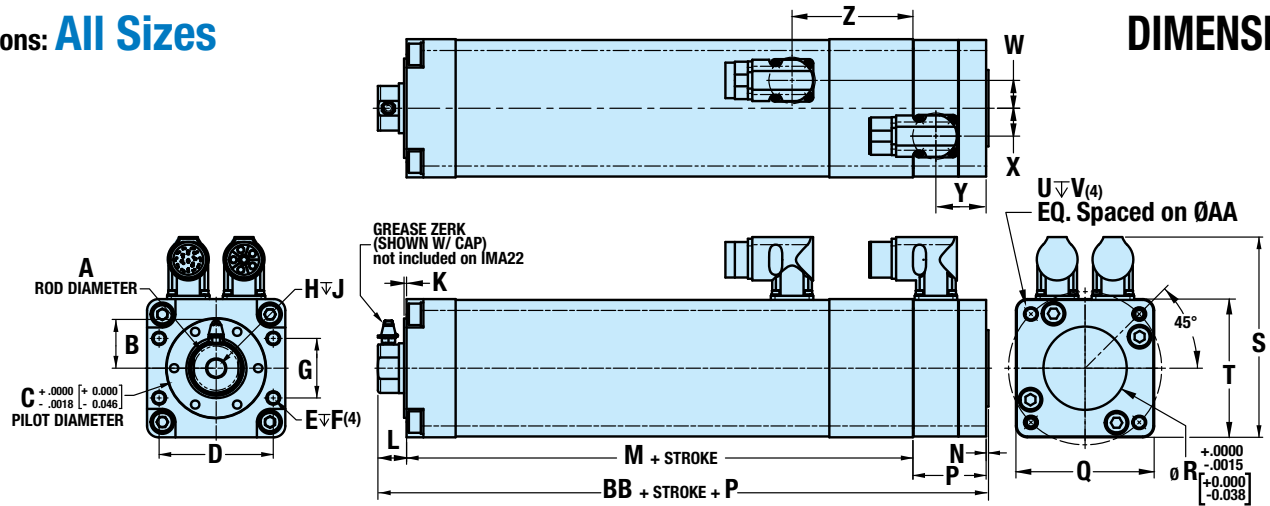

	IMA22	IMA33	IMA44	IMA55
A	25.38	30.13	38.08	57.13
B	—	28.3	32.3	41.9
C	48.000	60.000	72.000	100.000
D	54.00	69.00	85.00	110.00
E	M6 x 1.0	M8 x 1.25	M8 x 1.25	M12 x 1.75
F	13.2	14.5	17.1	22.5
G	20.00	36.00	55.00	65.00
H	M8 x 1.25	M12 x 1.25	M20 x 1.5	M27 x 2.0
J	16.5	22.2	25.9	38.1
K	1.5	1.5	1.5	1.5
L	17.3	17.3	16.8	24.1
M	109.8	153.7	200.0	266.2
N	1.5	1.5	1.5	1.5
P1	41.2	44.2	44.2	48.2
P2	86.7	80.8	80.0	96.8
P3	—	50.3	50.3	54.3
P4	—	93.5	89.0	96.8
P5	41.2	44.2	44.2	59.9
P6	86.7	80.8	80.0	96.8
P7	58.7	59.2	59.2	67.5
P8	96.3	100.6	99.1	111.5
P9	65.1	59.2	63.6	80.5
P10	107.2	100.6	99.1	122.9
Q	63.5	83.6	110.5	143.6
R	40.000	50.000	75.000	100.000
S1	104.4	124.6	151.4	184.3
S2	102.0	122.2	149.0	181.9
S3	—	113.5	140.4	173.3
T	63.5	83.6	110.5	143.6
U	M6 x 1.0	M8 x 1.25	M8 x 1.25	M12 x 1.75
V	13.5	16.5	16.5	20.5
W	9.5	16.8	22.2	22.2
X	9.5	16.8	22.2	22.2
Y	27.3	30.4	30.4	34.4
Z	60.6	73.1	77.9	86.9
AA	70.00	92.00	127.00	155.00
BB	128.6	172.5	218.3	291.8

Dimensions in millimeters

P1 = Dx1D1N	Digital Encoder
P2 = Dx1D1B	Digital Encoder with Brake
P3 = DE2D1N	*Digital Encoder (Nidec/Control Techniques NT)
P4 = DE2D1B	*Digital Encoder (Nidec/Control Techniques NT) w/ Brake
P5 = Dx1R1N	Resolver
P6 = Dx1R1B	Resolver with Brake

	IMA22	IMA33	IMA44	IMA55
A	0.999	1.186	1.499	2.249
B	—	1.11	1.27	1.65
C	1.8898	2.3622	2.8346	3.937
D	2.126	2.717	3.346	4.331
E	—	—	—	—
F	0.52	0.57	0.68	0.89
G	0.787	1.417	2.165	2.559
H	—	—	—	—
J	0.65	0.88	1.02	1.50
K	0.06	0.06	0.06	0.06
L	0.68	0.68	0.66	0.95
M	4.32	6.05	7.88	10.48
N	0.06	0.06	0.06	0.06
P1	1.62	1.74	1.74	1.90
P2	3.41	3.18	3.15	3.81
P3	—	1.98	1.98	2.14
P4	—	3.68	3.50	3.81
P5	1.62	1.74	1.74	2.36
P6	3.41	3.18	3.15	3.81
P7	2.31	2.33	2.33	2.66
P8	3.79	3.96	3.90	4.39
P9	2.56	2.33	2.50	3.17
P10	4.22	3.96	3.90	4.84
Q	2.50	3.29	4.35	5.66
R	1.5748	1.9685	2.9528	3.937
S1	4.11	4.91	5.96	7.26
S2	4.02	4.81	5.87	7.16
S3	—	4.47	5.53	6.82
T	2.50	3.29	4.35	5.66
U	—	—	—	—
V	0.53	0.65	0.65	0.80
W	0.38	0.66	0.88	0.88
X	0.38	0.66	0.88	0.88
Y	1.08	1.20	1.20	1.35
Z	2.39	2.88	3.07	3.42
AA	2.756	3.622	5.000	6.102
BB	5.06	6.79	8.6	11.49

Dimensions in inches

P7 = Dx1A1N	SICK Hiperface
DA2A2N	SICK Hiperface DSL
P8 = Dx1A1B	SICK Hiperface w/ Brake
DA2A2B	SICK Hiperface DSL w/ Brake
P9 = Dx1H4N	Heidenhain Endat 2.2
P10 = Dx1H4B	Heidenhain Endat 2.2 w/ Brake
S1 = DT1, DE1	Tolomatic Standard, Nidec/Control Techniques
DL1, DS1	FM, Lenze, Siemens

KEY FEATURES: 1-STACK & 3-STACK MOTORS

IMA22			
	SERIES	MV21/41	MV23/43
STROKE	mm	76.2 to 304.8	152.4 to 304.8
	in	3.0 to 12.0	6.0 to 12.0
PEAK THRUST	N	up to 1,446	up to 1,446
	lbf	up to 325	up to 325

IMA33			
	SERIES	MV21/41	MV23/43
STROKE	mm	76.2 to 457.2	152.4 to 457.2
	in	3.0 to 18.0	6.0 to 18.0
PEAK THRUST	N	up to 4,673	up to 11,100
	lbf	up to 1,050	up to 2,500

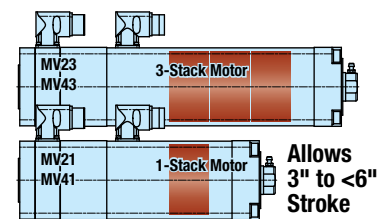

S2 = DB1	Bosch MSK Motor Series
S3 = DE2	Nidec/Control Techniques NT Series
*Uses Box Mount Connectors (IP67 not available) Not available as standard on IMA22	



Dimensions: Rod End Options

EXTERNAL THREADED ROD END (MET)

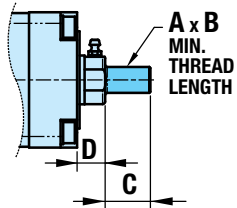
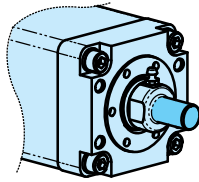

CLEVIS ROD END (RCL)

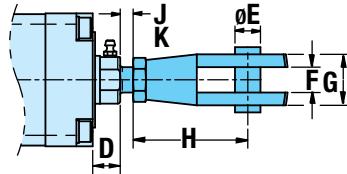
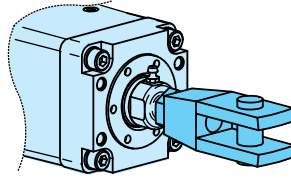

SPHERICAL ROD EYE (SRE)

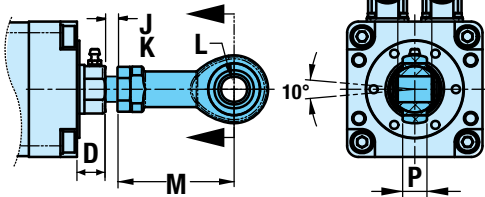
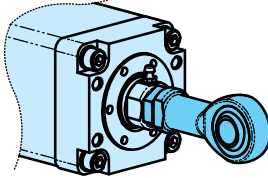

ALIGNMENT COUPLER (ALC + MET)

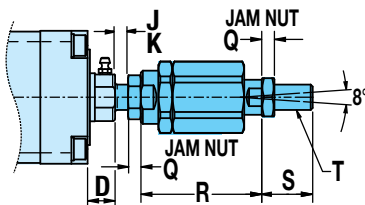
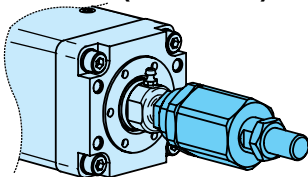

ALIGNMENT COUPLER FEMALE (ALC) *

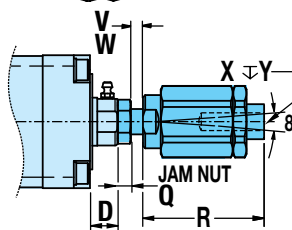
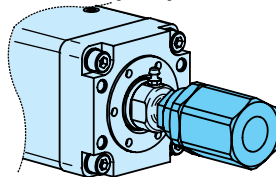

*For IMA44 & IMA55 Only

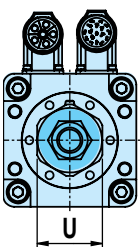

	IMA22	IMA33	IMA44	IMA55
A	M10 x 1.25	M16 x 1.5	M20 x 1.5	M27 x 2.0
B	22.1	34.3	41.4	38.1
C	24.6	37.3	44.5	50.8
D	17.3	17.3	16.8	24.1
E	10.00	16.00	20.00	30.00
F	10.0	16.0	20.0	30.0
G	20.0	32.0	40.0	55.0
H	45.0	72.0	90.0	123.5
J	9.1	13.2	14.2	10.1
K	2.5	3.0	3.0	5.1
L	10.00	16.00	20.00	30.00
M	48.0	72.0	87.0	123.5
N	14.0	21.0	25.0	37.0
P	12.5	15.0	18.0	25.0
Q	5.0	8.0	10.0	13.5
R	53.0	76.0	82.0	93.0
S	20.0	32.0	40.0	54.0
T	M10 x 1.25	M16 x 1.5	M20 x 1.5	M27 x 2.0
U	30.0	41.0	42.0	55.0
V	-	-	11.0	11.0
W	-	-	4.1	2.4
X	-	-	M20 x 1.5	M27 x 1.75
Y	-	-	42.0	54.0

Dimensions in millimeters

	IMA22	IMA33	IMA44	IMA55
A	-	-	-	-
B	0.87	1.35	1.63	1.80
C	0.97	1.47	1.75	2.00
D	0.68	0.68	0.66	0.95
E	0.394	0.630	0.787	1.181
F	0.39	0.63	0.79	1.18
G	0.79	1.26	1.57	2.17
H	1.77	2.83	3.54	4.86
J	0.36	0.52	0.56	0.40
K	0.10	0.12	0.12	0.20
L	0.394	0.630	0.787	1.181
M	1.89	2.84	3.43	4.86
N	0.55	0.83	0.98	1.46
P	0.49	0.59	0.71	0.94
Q	0.20	0.32	0.39	0.53
R	2.09	2.99	3.23	3.66
S	0.79	1.26	1.57	2.16
T	-	-	-	-
U	1.18	1.61	1.65	2.17
V	-	-	0.43	0.43
W	-	-	0.16	0.09
X	-	-	-	-
Y	-	-	1.65	2.13

Dimensions in inches



Dimensions: Mounting Options

DIMENSIONS

FRONT FLANGE MOUNT (FFG)

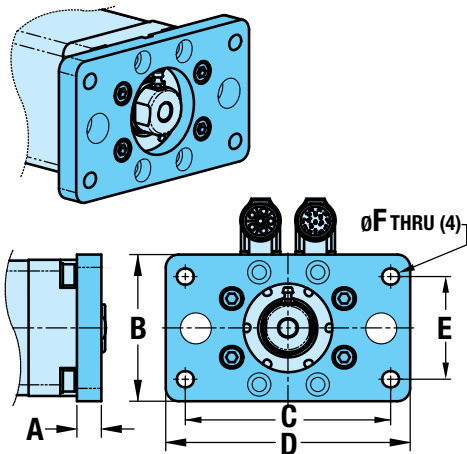

FRONT TRUNNION MOUNT (TRF)

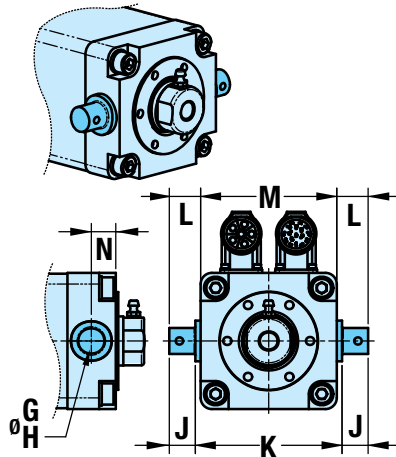

	IMA22	IMA33	IMA44	IMA55
A	11.2	15.0	16.0	17.8
B	67.3	87.0	110.5	150.0
C	100.00	126.00	150.00	230.00
D	117.3	150.0	170.0	260.0
E	50.00	63.00	75.00	115.00
F	8.7	12.3	14.7	16.7
G	11.99	15.98	19.99	24.99
H	11.96	15.95	19.96	24.97
J	8.6	16.0	20.1	24.9
K	68.0	90.0	123.0	160.0
L	10.9	19.2	26.3	33.1
M	63.5	83.6	110.5	143.6
N	15.0	15.0	21.0	28.0
Q	26.000 ¹	32.000	50.000	60.000
R	45.000 ²	60.000	90.000	110.000 ⁴
S	10.000 ³	12.000	16.000	20.000 ⁵
T	20.00	24.00	36.00	40.00
U	13.00	16.00	22.00	27.00
V	11.99	15.98	19.99	24.99
W	11.96	15.95	19.96	24.97
X	8.6	16.0	20.1	24.9
Y	68.0	90.0	123.0	160.0
Z	10.9	19.2	26.3	33.1
AA	63.5	83.6	110.5	143.6
BB	15.0	20.0	25.0	32.0

Dimensions in millimeters

REAR CLEVIS MOUNT (PCD)

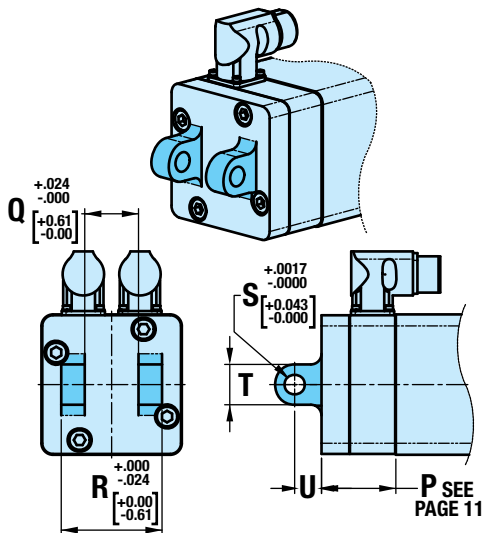

- 1 +0.520mm/-0.000mm
- 2 +0.000mm/-0.620mm
- 3 +0.036mm/-0.000mm
- 4 +0.000mm/-0.870mm
- 5 +0.052mm/-0.000mm

REAR TRUNNION MOUNT (TRR)

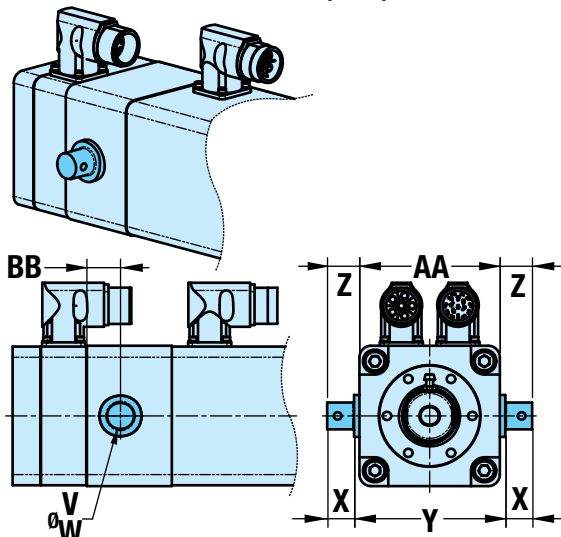

- 1 +0.0205"/-0.0000"
- 2 +0.0000"/-0.0244"
- 3 +0.0014"/-0.0000"
- 4 +0.0000"/-0.0343"
- 5 +0.0020"/-0.0000"

Dimensions in inches

	IMA22	IMA33	IMA44	IMA55
A	0.44	0.59	0.63	0.70
B	2.65	3.43	4.35	5.91
C	3.937	4.961	5.906	9.055
D	4.62	5.91	6.69	10.24
E	1.969	2.480	2.953	4.528
F	0.34	0.48	0.58	0.66
G	0.472	0.629	0.787	0.984
H	0.471	0.628	0.786	0.983
J	0.34	0.63	0.79	0.98
K	2.68	3.54	4.84	6.30
L	0.43	0.76	1.04	1.30
M	2.50	3.29	4.35	5.66
N	0.59	0.59	0.83	1.10
Q	1.0236 ¹	1.2598	1.9685	2.3622
R	1.7717 ²	2.3622	3.5433	4.3307 ⁴
S	0.3937 ³	0.4724	0.6299	0.7874 ⁵
T	0.787	0.945	1.417	1.575
U	0.512	0.630	0.866	1.063
V	0.472	0.629	0.787	0.984
W	0.471	0.628	0.786	0.983
X	0.34	0.63	0.79	0.98
Y	2.68	3.54	4.84	6.30
Z	0.43	0.76	1.04	1.30
AA	2.50	3.29	4.35	5.66
BB	0.59	0.79	0.98	1.26



Dimensions: Options

SIDE MOUNTING (MST)

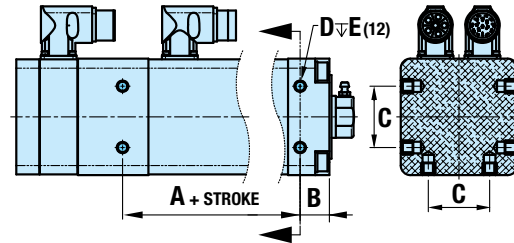
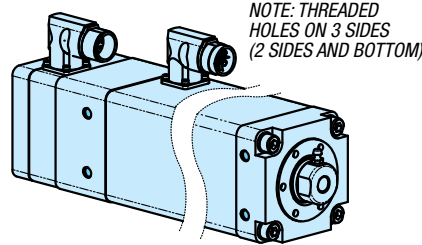

MOUNTING PLATES (MP2)

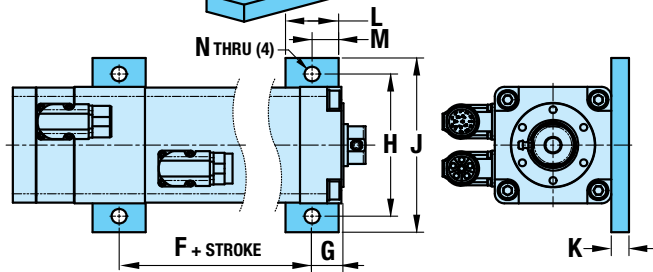
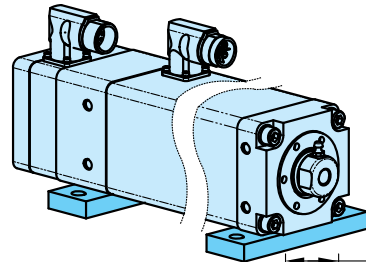

ANTI ROTATE (ARO)

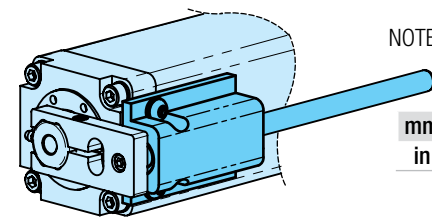

NOTE: When ARO is used together with FFG, stroke is reduced by dimension below

	IMA22	IMA33	IMA44	IMA55
mm	7.6	11.4	13.0	11.2
in	0.30	0.45	0.51	0.44

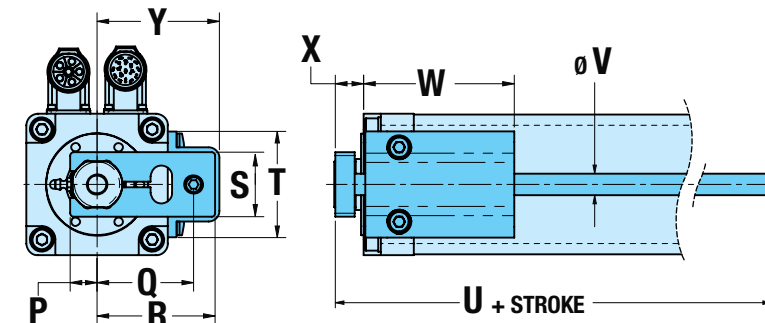

	IMA22	IMA33	IMA44	IMA55
A	67.8	100.7	143.0	191.2
B	20.0	21.0	25.0	30.0
C	34.00	44.00	50.00	85.00
D	M6 X 1.0	M8 x 1.25	M8 x 1.25	M12 x 1.75
E	13.1	14.5	17.1	22.5
F	67.8	100.7	143.0	191.2
G	20.0	21.0	25.0	30.0
H	80.00	102.00	130.00	170.00
J	100.0	125.0	155.0	200.0
K	11.0	12.7	12.7	20.0
L	30.0	38.1	38.1	50.0
M	15.0	19.1	19.1	0.5
N	8.7	10.7	10.7	15.1
P	12.7	15.9	19.8	31.8
Q	43.3	57.0	70.5	95.1
R	51.2	69.7	83.2	109.7
S	34.8	38.1	45.9	68.2
T	46.2	62.7	62.7	106.7
U	81.0	105.2	108.5	142.5
V	9.5	12.7	12.7	19.1
W	65.0	89.0	93.0	115.6
X	16.1	16.1	15.5	22.8
Y	54.9	72.3	85.7	118.3

Dimensions in millimeters

	IMA22	IMA33	IMA44	IMA55
A	2.67	3.97	5.63	7.53
B	0.79	0.83	0.98	1.18
C	1.339	1.732	1.969	3.346
D	-	-	-	-
E	0.52	0.57	0.68	0.89
F	2.67	3.97	5.63	7.53
G	0.79	0.83	0.98	1.18
H	3.150	4.016	5.118	6.693
J	3.94	4.92	6.10	7.87
K	0.43	0.50	0.50	0.79
L	1.18	1.50	1.50	1.97
M	0.59	0.75	0.75	0.98
N	0.34	0.42	0.42	0.59
P	0.50	0.63	0.78	1.25
Q	1.71	2.24	2.78	3.74
R	2.02	2.75	3.28	4.32
S	1.37	1.50	1.81	2.69
T	1.82	2.47	2.47	4.20
U	3.19	4.14	4.27	5.60
V	0.38	0.50	0.50	0.75
W	2.56	3.50	3.66	4.55
X	0.63	0.63	0.61	0.90
Y	2.16	2.85	3.38	4.66

Dimensions in inches

The IMA is matched to your drive/controller choice

The IMA has been successfully integrated with the following servo drive/controller and robot companies:

Controller/ Drive Manufacturers

- Aerotech BM*
- Allen Bradley MP & VP
- B&R 8LS*
- Baldor BSM
- Beckhoff AM8*
- Bosch Rexroth MSK
- Kollmorgen AKM*
- Lenze MCA
- Nidec/Control Techniques FM & NT
- Omron*
- Parker MPP*
- Schneider Electric SH*
- SEW CMP*
- Siemens 1F
- Stober*
- Others

Robot Manufacturers

- ABB*
- Fanuc*
- Kawasaki*
- Kuka*
- Motoman*
- Nachi*
- Others

* Consult Tolomatic for lead time



Contact Tolomatic if your preferred servo drive/controller or robot supplier is not listed above.



Licensed
Partner

For additional information regarding the integration of the IMA to an Allen Bradley/Rockwell drive see tech note linked below:

[3600-4187 TN IMA-AB-servo.pdf](#)

The IMA is the most rigorously tested Tolomatic product yet

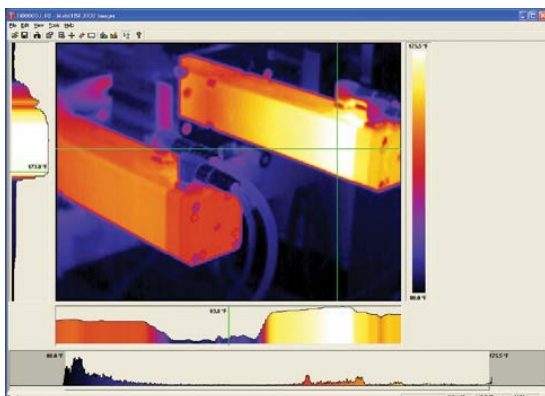

Cutting edge products like the IMA don't just fall into place. Over 20,000 hours of testing were required to prove the design that ships today. Thermal imaging, dynamic loading and other state-of-the-art techniques give us the confidence to stand behind our published performance data.

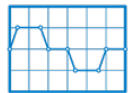

Selection Guidelines

1 ESTABLISH MOTION PROFILE

Using the application stroke length, desired cycle time and loads establish the motion profile details.

2 COMPARE OPERATING (PEAK) THRUST AND SPEED TO OPERATING REGION

Calculate the application required operating (peak) thrust and speed and compare to tables on pages IMA_6-7. The calculated thrust and speed must fall within the operating region of the actuator.

3 COMPARE SEVERE DUTY (CONTINUOUS) THRUST AND SPEED TO SEVERE DUTY REGION

Calculate the RMS thrust and speed required and compare to tables on pages IMA_6-7. The calculated thrust and speed must fall within the severe duty region. See complete instructions on page IMA_10 for help calculating continuous force.

$$T_{RMS} = \sqrt{\frac{\sum (T_i^2 \times t_i)}{\sum (t_i)}} \quad V_{RMS} = \sqrt{\frac{\sum (V_i^2 \times t_i)}{\sum (t_i)}}$$

4 CONSIDER SCREW/NUT CHOICES

Choose roller nuts for its longer life (see Life graph on page IMA_9) and higher peak loads. Ball nuts are cost competitive and more efficient (see table on page IMA_6).

SCREW ACCURACY

Roller Nut	± 0.0004"/ft.	± 0.0102mm/300mm
Ball Nut	± 0.002"/ft.	± 0.051mm/300mm

5 VERIFY CRITICAL SPEED OF THE SCREW

Verify that the application's peak linear velocity does not exceed the critical speed value for the size and lead of the screw selected.

6 VERIFY AXIAL BUCKLING STRENGTH OF THE SCREW (ROLLER SCREW)

Verify that the peak thrust does not exceed the critical buckling force for the size of the screw selected.

7 MOTOR WINDINGS & VOLTAGES

Choose motor windings optimized for 230 Vac and 460 Vac voltage busses. The 1 stack motor (MV21-230V & MV41-460V), available for the IMA22/33, allows strokes between 3 and 6" providing the thrust needed for many applications in a more compact, lighter weight package

8 CALCULATE LUBRICATION INTERVAL

See page IMA_10 for an overview and IMA Users Guide (#2700-4001) for complete instructions to calculate lubrication interval.

9 TEMPERATURE

The IMA is intended to operate in an environment with an ambient temperature between 50-104°F, (10-40°C). Performance should be de-rated if the ambient temperature is above 77°F (25°C). Contact the factory if the ambient temperature does not fit within this range. NOTE: Temperature of the actuator's body can approach 180°F

(82°C) in aggressive applications. Adequate clearance to ensure actuator's ambient conditions do not rise drastically should be allowed.

10 BRAKE CONSIDERATIONS

In all vertical application an unpowered IMA will require a brake to maintain position. Tolomatic recommends that the nominal back drive force specification be used for reference only. Back drive force is subject to change throughout the life of the actuator, due to mechanical break in, ambient temperature, and duty cycle variation.

A brake can be used with the actuator to keep it from back-driving, typically in vertical applications. A brake may be used for safety reasons or for energy savings allowing the actuator to hold position when unpowered. See page IMA_19 for ordering information.

NOTE: The optional Spring-Applied/Electronically Released Brake requires 24V power. Input current rating:
 IMA22 - 0.35 Amps; IMA33 - 0.43 Amps;
 IMA44 - 0.67 Amps; IMA55 - 0.66 Amps.

11 CHOOSE MOTOR CONNECTORS & FEEDBACK DEVICE

Connector choice and wiring emulates popular motor manufacturers for compatibility.

Current connector choices include:

- Bosch Rexroth MSK Series
- Control Techniques FM & NT
- Lenze MCA Series

Current feedback choices include:

- Incremental Encoder
- Absolute Encoder, Hiperface, Hiperface DSL, EnDat 2.2
- Resolver

Contact Tolomatic for additional motor connectors, feedback combinations and motor files for third party drives.

12 CONSIDER MOUNTING & ROD END OPTIONS

Examine mounting options dimensional drawings on page IMA_11-14. Standard mounting on the IMA are 4 tapped holes on the front rod end face of the actuator. The Side Mount option (MST) includes 12 tapped holes, 4 on each side and 4 on the bottom of the actuator. Other fixed mounting options are the Front Flange Mount (FFG) and Mounting Plates (MP2). Pivoting mount options are Front Trunnion (TRF), Rear Trunnion (TRR) and Rear Clevis Mount (PCD).

Rod End Options include: External Threaded Rod End (MET), Clevis Rod End (RCL), Spherical Rod Eye (SRE) and Alignment Coupler (ALC).

NOTE: Regardless of the mounting option chosen, care must be taken to ensure that the load is guided and in-line with the thrust rod's line of motion. Misalignment of the thrust rod's line of motion will cause degradation in the actuator's expected life.

13 CONSIDER ENVIRONMENTAL RATING AND ANTI-ROTATE OPTIONS

The environmental rating for a standard IMA is IP65, choose IP67 for protection against water and dust ingress. Choose the Anti-Rotate Option (ARO) if required. Call Tolomatic at 1-800-328-2174 for help in determining the best actuator for your application.

APPLICATION DATA WORKSHEET

Fill in known data. Not all information is required for all applications

sizeit.tolomatic.com
for fast, accurate
actuator selection

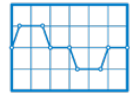

ORIENTATION

Horizontal

Vertical

Incline °

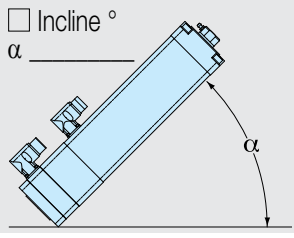
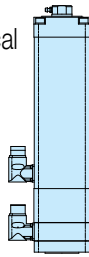
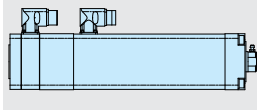

Load supported by actuator OR Load supported by other mechanism

MOVE PROFILE

EXTEND

Move Distance _____

inch millimeters

Move Time _____ sec

Max. Speed _____

in/sec mm/sec

Dwell Time After Move _____ sec

RETRACT

Move Distance _____

inch millimeters

Move Time _____ sec

Max. Speed _____

in/sec mm/sec

Dwell Time After Move _____ sec

NO. OF CYCLES

per minute per hour

HOLD POSITION?

Required

Not Required

After Move

During Power Loss

STROKE LENGTH

order in _____
mm ONLY millimeters (S M)
(Metric)

NOTE: If load or force changes during cycle use the highest numbers for calculations

EXTEND

LOAD

lb kg
(U.S. Standard) (Metric)

FORCE

lbf N
(U.S. Standard) (Metric)

RETRACT

LOAD

lb kg
(U.S. Standard) (Metric)

FORCE

lbf N
(U.S. Standard) (Metric)

PRECISION

Repeatability _____

inch millimeters

OPERATING ENVIRONMENT

Temperature, Contamination, Water, etc.

MOTION PROFILE

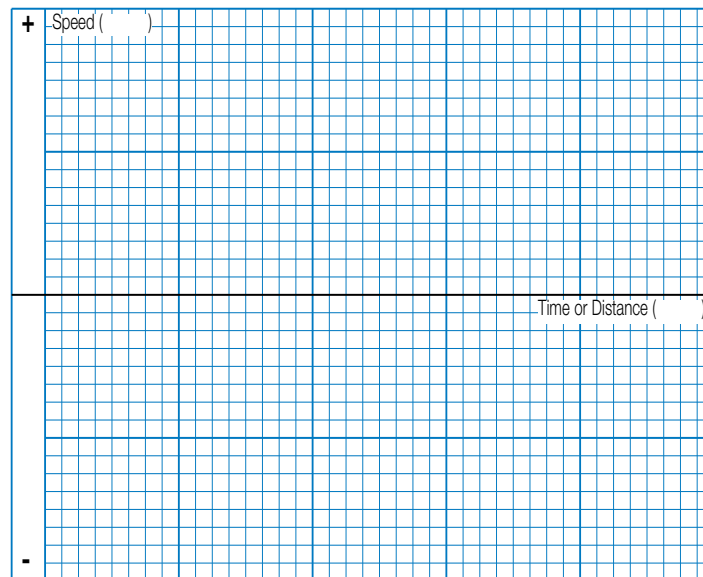

Graph your most demanding cycle, including accel/decel, velocity and dwell times. You may also want to indicate load variations and I/O changes during the cycle. Label axes with proper scale and units.

CONTACT INFORMATION

Name, Phone, Email
Co. Name, Etc.



USE THE TOLOMATIC SIZING AND SELECTION SOFTWARE AVAILABLE ON-LINE AT

www.tolomatic.com OR... CALL TOLOMATIC AT 1-800-328-2174. We will provide any

assistance needed to determine the proper actuator for the job.

EMAIL help@tolomatic.com

IMA - Integrated Motor Actuator

Replacement Option Parts Ordering

PART NO.	DESCRIPTION
2722-9014	Spherical Rod Eye Kit, IMA22
2733-9014	Spherical Rod Eye Kit, IMA33
2744-9014	Spherical Rod Eye Kit, IMA44
2755-9014	Spherical Rod Eye Kit, IMA55
2722-9015	Clevis Rod End Kit, IMA22
2733-9015	Clevis Rod End Kit, IMA33
2744-9015	Clevis Rod End Kit, IMA44
2755-9015	Clevis Rod End Kit, IMA55
2124-1070	Alignment Coupler Kit, IMA22
2132-1060	Alignment Coupler Kit, IMA33
2150-1060	Alignment Coupler Kit, IMA44
2164-1060	Alignment Coupler Kit, IMA55
2722-9010	Mounting Plate Kit, IMA22
2733-9010	Mounting Plate Kit, IMA33
2744-9010	Mounting Plate Kit, IMA44
2755-9010	Mounting Plate Kit, IMA55
2722-9018	Front Flange Mount Kit, IMA22
2733-9018	Front Flange Mount Kit, IMA33
2744-9018	Front Flange Mount Kit, IMA44
2755-9018	Front Flange Mount Kit, IMA55
2722-2045	Rear Clevis Mount, IMA22
2733-1045	Rear Clevis Mount, IMA33
2744-1045	Rear Clevis Mount, IMA44
2755-1045	Rear Clevis Mount, IMA55
2722-9075	Anti Rotate, Bearing Assy, IMA22
2733-9075	Anti Rotate, Bearing Assy, IMA33 & 44
2755-9075	Anti Rotate, Bearing Assy, IMA55
2722-9074	Anti Rotate, Shaft Clamp Assy, IMA22
2722-2211	Anti Rotate, Shaft, IMA22 - Indicate Stroke
2733-9074	Anti Rotate, Shaft Clamp Assy, IMA33

PART NO.	DESCRIPTION
2733-1211	Anti Rotate, Shaft, IMA33 - Indicate Stroke
2744-9074	Anti Rotate, Shaft Clamp Assy, IMA44
2744-1211	Anti Rotate, Shaft, IMA44 - Indicate Stroke
2755-9074	Anti Rotate, Shaft Clamp Assy, IMA55
2755-1211	Anti Rotate, Shaft, IMA55 - Indicate Stroke
2733-1611	Motor Power Cable, M23, 6 Pin, 5m, 460V AC
2733-1612	Motor Power Cable, M23, 6 Pin, 5m, 460V AC, Brake
2733-1613	Encoder Cable, M23, 12 Pin, 5m, Resolver/ Absolute
2733-1614	Encoder Cable, M23, 17 Pin, 5m, Incremental
2744-1488	Motor Power Cable, M23, 6 Pin, 5m, 230V AC
2744-1489	Motor Power Cable, M23, 6 Pin, 5m, 230V AC, Brake
2733-1221	Motor Power Cable, M23, 6 Pin, 10m, 460V AC
2733-1222	Motor Power Cable, M23, 6 Pin, 10m, 460V AC, Brake
2733-1223	Encoder Cable, M23, 12 Pin, 10m, Resolver/ Absolute
2733-1224	Encoder Cable, M23, 17 Pin, 10m, Incremental
2744-1221	Motor Power Cable, M23, 6 Pin, 10m, 230V AC
2744-1222	Motor Power Cable, M23, 6 Pin, 10m, 230V AC, Brake
2744-1016	Mobilith SHC220 Grease (Ball nut/screw)
2744-9099	Grease (Roller nut/screw)
2552-1132	Wiper, IMA22
2115-1030	Wiper, IMA33
2744-1003	Wiper, IMA44
2140-1030	Wiper, IMA55
2744-1213	Zerk Cap
2744-9092	Kit, Zerk with Cap
2744-1214	Grease Ftg. Plug

All parts are listed for REPLACEMENT ONLY. If not ordered on original unit the IMA may require additional tapped holes or replacement rod end. Contact Tolomatic.

*Not valid with DA2A2X option



IMA - Integrated Motor Actuator

Ordering

MODEL SELECTION (MUST BE IN THIS ORDER)

IMA 44 BN05 SM304-8 MV23 DT1D1 N ALC MP2 IP67 CR5

MODEL	
IMA	Integrated Motor Actuator

SIZE	
22	22 Series Actuator
33	33 Series Actuator
44	44 Series Actuator
55	55 Series Actuator

NUT / SCREW				
Screw/Nut combinations available				
22	33	44	55	Description
BN05	BN05	BN05	BN05	Ball Nut, 5 mm lead
BN10	BN10	BN10	BN10	Ball Nut, 10 mm lead
—	BN20	—	BN20	Ball Nut, 20 mm lead
—	—	BN25	—	Ball Nut, 25 mm lead
—	RN04	RN04	—	Roller Nut, 4 mm lead
—	RN05	RN05	RN05	Roller Nut, 5 mm lead
—	RN10	RN10	RN10	Roller Nut, 10 mm lead

STROKE LENGTH	
SM	Stroke, (76.2 to 457.2) enter stroke length in millimeters
<i>NOTE: Maximum stroke for IMA22 is 12" (304.8 mm)</i>	

MOTOR VOLTAGE	
MV21*	230 Vac, Motor Voltage, 1 Stack Winding
MV41*	460 Vac, Motor Voltage, 1 Stack Winding
MV23	230 Vac, Motor Voltage, 3 Stack Winding
MV43	460 Vac, Motor Voltage, 3 Stack Winding
<i>*NOTE: 22/33 size actuators only</i>	

OPTIONS (IN ANY ORDER)

BRAKE OPTION	
N	NO Brake
B	Brake

ROD END OPTIONS	
—	Standard, female, internally threaded rod end
MET	Male Externally Threaded Rod End
SRE	Spherical Eye Rod End
RCL	Clevis Rod End
ALC	Alignment Coupler*
<i>*NOTE: ALC requires ARO (Anti-Rotate). For IMA22 & 33 the MET option is also required.</i>	

MOUNTING OPTIONS	
—	Standard Face Mount
MP2	Mounting Plates - 2 req.
FFG	Front Flange Mount
TRF	Trunnion Mount, Front
TRR	Trunnion Mount, Rear
PCD	Clevis Mount, Rear
MST	Side Mount (tapped holes on 3 sides)

OTHER OPTIONS	
IP67**	Ingress Protection Rating
ARO	Anti Rotate
LUB	Food Grade Grease
<i>**IP67 is not available with DE2 (Control Techniques NT connectors) Not available on any IMA22</i>	

CABLES	
CR5	Tolomatic standard 5m flying lead cables, power and feedback
CR10	Tolomatic standard 10m flying lead cables, power and feedback
For custom cable lengths please contact Tolomatic. Lead times will vary.	
<i>*NOTE: only use these cable options with DT1 motor connector, use cables from drive manufacturer for all others.</i>	
For IP rated cables contact Tolomatic	

MOTOR SERIES CONNECTORS	FEEDBACK DEVICE
Allen Bradley MP DA1	A1 SICK Hiperface
Allen Bradley VP DA2	A2 SICK Hiperface DSL
Bosch Rexroth MSK DB1	A1 SICK Hiperface
Nidec/Cntl. Tech., FM DE1	A1 SICK Hiperface
Nidec/Cntl. Tech., FM DE1	R1 Resolver
Nidec/Cntl. Tech., FM DE1	D1 Incremental
Nidec/Cntl. Tech., NT DE2	D1 Incremental
Lenze MCS DL1	A1 SICK Hiperface
Lenze MCS DL1	R1 Resolver
Lenze MCS DL1	D1 Incremental

MOTOR SERIES CONNECTORS	FEEDBACK DEVICE
Siemens 1F DS1	H4 Heidenhain Endat 2.2
Tolomatic Standard DT1	D1 Incremental
Tolomatic Standard DT1	R1 Resolver
Tolomatic Standard DT1	A1 SICK Hiperface
Tolomatic Standard DT1	H1 Heidenhain Endat 2.2
Motor Connector or Feedback Device Not Shown DX	***See below

*** Tolomatic can configure the IMA to connect to a drive using cables from other leading drive manufactures including but not limited to those listed below.

ABB	Fanuc	Motoman	SEW
Aerotech	Kawasaki	Nachi	Stober
B&R	Kollmorgen	Omron	Others
Baldor	Kuka	Parker	
Beckhoff	Lenze	Schneider Electric	

This integration includes customer specified motor thermal protection, feedback, connectors, flying lead/connectorized extension cables and motor alignment.

For more information about combinations not listed above, or other customizations, contact Tolomatic.



tolomatic.com/CAD
Download 3D CAD
Always use CAD solid model to determine critical dimensions



tolomatic.com/ask
Technical support
before and after purchase

The Tolomatic Difference Expect More From the Industry Leader:



INNOVATIVE PRODUCTS

Solutions with Endurance TechnologySM for challenging applications.



FAST DELIVERY

Built-to-order with configurable stroke lengths and flexible mounting options.

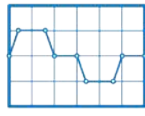

ACTUATOR SIZING

Size and select electric actuators with our online software.



YOUR MOTOR HERE[®]

Match your motor to compatible mounting plates with Tolomatic actuators.



CAD LIBRARY

Download 2D or 3D CAD files for Tolomatic products.



TECHNICAL SUPPORT

Get a question answered or request a virtual design consultation with one of our engineers.

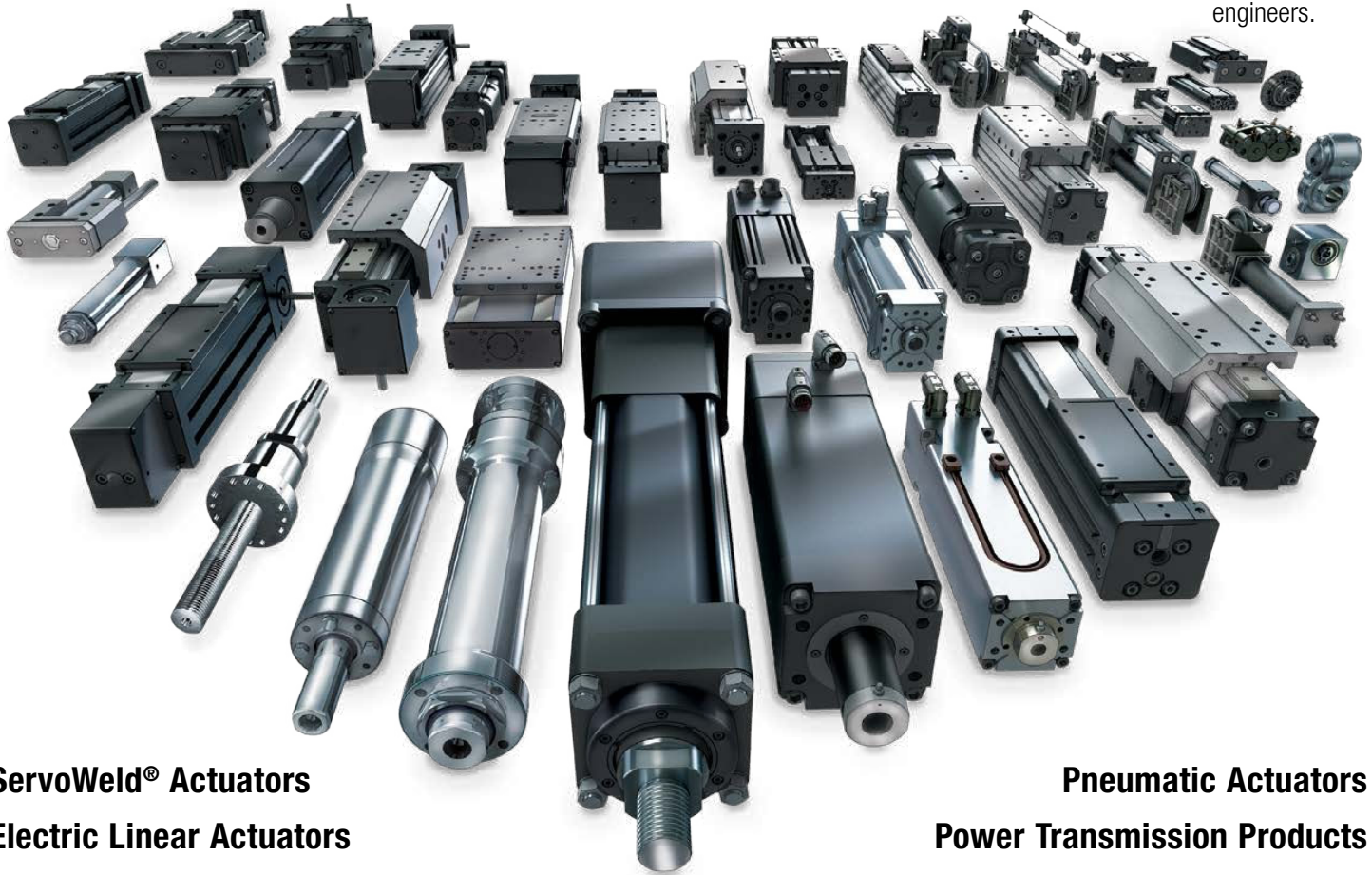

ServoWeld[®] Actuators
Electric Linear Actuators

Pneumatic Actuators
Power Transmission Products



MADE IN U.S.A.

Tolomatic[™]

EXCELLENCE IN MOTION

COMPANY WITH
QUALITY SYSTEM
CERTIFIED BY DNV
= ISO 9001 =
Certified site: Hamel, MN

USA - Headquarters

Tolomatic Inc.

3800 County Road 116
Hamel, MN 55340, USA
Phone: (763) 478-8000
Toll-Free: **1-800-328-2174**
sales@tolomatic.com
www.tolomatic.com

MEXICO

Centro de Servicio

Parque Tecnológico Innovación
Int. 23, Lateral Estatal 431,
Santiago de Querétaro,
El Marqués, México, C.P. 76246
Phone: +1 (763) 478-8000
help@tolomatic.com

EUROPE

Tolomatic Europe GmbH

Elisabethenstr. 20
65428 Rüsselsheim
Germany
Phone: +49 6142 17604-0
help@tolomatic.eu
www.tolomatic.com/de-de

CHINA

Tolomatic Automation Products (Suzhou) Co. Ltd.

No. 60 Chuangye Street, Building 2
Huqiu District, SND Suzhou
Jiangsu 215011 - P.R. China
Phone: +86 (512) 6750-8506
Tolomatic_China@tolomatic.com

All brand and product names are trademarks or registered trademarks of their respective owners. Information in this document is believed accurate at time of printing. However, Tolomatic assumes no responsibility for its use or for any errors

that may appear in this document. Tolomatic reserves the right to change the design or operation of the equipment described herein and any associated motion products without notice. Information in this document is subject to change without notice.

Visit www.tolomatic.com for the most up-to-date technical information