

Linear measuring technology

Absolute magnetic measurement system sensor head, magnetic	Limes LA10 / BA1	Measuring length max. 8 m Resolution min. 1 µm
---	-------------------------	---



The non-contact absolute magnetic linear measurement system Limes LA10 / BA1 - made up of the sensor head LA10 and of the magnetic band BA1 - reaches a resolution up to 1 µm with a maximum distance of 0.2 mm between the sensor and the band (incl. masking tape).

The additional SinCos interface makes the measurement system LA10 / BA1 the optimal equipment for use in the linear drive technology.



DC 10 ... 30 V	8 m Max. measuring length	0,2 mm Max. distance to measuring tape	10 m/s Max. speed	1 µm High resolution	IP64 Protection	Reverse polarity protection	Shock / vibration resistant	-10°...+70°C Temperature range	SinCos
--------------------------	-------------------------------------	--	-----------------------------	--------------------------------	---------------------------	------------------------------------	------------------------------------	--	---------------

Robust and versatile

- High resolution - 1µm / measuring length max. 8 m.
- Non-contact magnetic absolute measuring technology – therefore no wear – no referencing movement required.
- Sturdy housing with IP64 protection.
- For highly dynamic control.
- Optional SinCos signal (1 Vpp) for dynamic movement control with 1 mm pole pitch.
- Masking tape protecting the magnetic band.

Easy installation

- Simple glued assembly of the magnetic band.
- Requires very little installation space.
- Robust measuring principle – insensitive to dirt, smoke and humidity.

Order code sensor head Limes LA10

8.LA10 . **12X2**
Type a b c d

- | | |
|--|--|
| <p>a Model
1 = IP64, standard</p> <p>b baud rate
2 = standard
(CANopen, 250 k)</p> | <p>c Output circuit / Supply voltage
1 = SSI, 25 bit Gray-Code / 10 ... 30 V DC
2 = SSI, 25 bit Gray-Code, SinCos 1 Vpp / 10 ... 30 V DC
3 = CANopen, without bus terminating resistor / 10 ... 30 V DC
4 = CANopen, with bus terminating resistor / 10 ... 30 V DC
5 = CANopen, SinCos 1 Vpp, without bus terminating resistor / 10 ... 30 V DC
6 = CANopen, SinCos 1 Vpp, with bus terminating resistor / 10 ... 30 V DC</p> <p>d Type of connection
2 = standard, M12 connector, 12 pin</p> |
|--|--|

Scope of delivery
sensor head + spacing template

Optional on request
- other baud rate

Order code magnetic band Limes BA1

8.BA1 . **10** . **010** . **XXXX**
Type a b

- | | | |
|--------------------------------------|---|---|
| <p>a Width
10 = 10 mm</p> | <p>b Length (measuring range = length - 0.1 m)
0005 = 0.5 m 0040 = 4 m
0010 = 1 m 0060 = 6 m
0020 = 2 m 0080 = 8 m
0030 = 3 m</p> | <p><i>Optional on request</i>
- other lengths</p> |
|--------------------------------------|---|---|

Linear measuring technology

Absolute magnetic measurement system sensor head, magnetic band		Limes LA10 / BA1	Measuring length max. 8 m Resolution min. 1 µm
Accessories			Order no.
SSI display type 570T Position display, 8-digit	with 2 relay outputs and serial interface DC supply voltage		6.570T.010.300
	with 4 fast switch outputs and serial interface AC/DC supply voltage		6.570T.012.E01
	with 4 fast switch outputs, serial interface and scalable analog output AC/DC supply voltage		6.570T.012.E02
	with 4 fast switch outputs and RS485 interface AC/DC supply voltage		6.570T.012.E03
Connection technology			Order no.
Connector, self-assembly (straight)	M12 female connector with coupling nut, 12 pin, A coded		8.0000.5162.0000
Cordset, pre-assembled	M12 female connector with coupling nut, 12 pin, 5 m [16.4'] PUR cable 6 x 2 x 0.14 mm ² [AWG 26]		05.00.60B1.B211.005M
Unprepared cable, cut to length	6 x 2 x 0.14 mm ² [AWG 26] PVC cable		8.0000.6900.XXXX ¹⁾
	6 x 2 x 0.14 mm ² [AWG 26] PUR cable		8.0000.6Y00.XXXX ¹⁾
	5 x 2 x 0.14 mm ² [AWG 26] PVC cable		8.0000.6Z00.XXXX ¹⁾

Further accessories can be found in the accessories section or in the accessories area of our website at: www.kuebler.com/accessories.
Additional connectors can be found in the connection technology section or in the connection technology area of our website at: www.kuebler.com/connection_technology.

Technical data	
Mechanical characteristics	
Weight	approx. 0.1 kg [3.53 oz]
Working temperature	-10 °C ... +70 °C [+14 °F ... +158 °F] (non condensing)
Storage temperature	-25 °C ... +85 °C [-13 °F ... +185 °F]
Protection acc. to EN 60529	IP64
Housing	aluminum
Max. traverse speed	SinCos reading 10 m/s permanent absolute positions reading 1 m/s
Shock resistance acc. to EN 60068-2-27	5000 m/s ² , 1 ms
Vibration resistance acc. to EN 60068-2-6	300 m/s ² , 10 ... 2000 Hz
Distance sensor head / magnetic band	0.01 ... 0.2 mm incl. masking tape (recommended 0.2 mm)
Measuring length	max. 8 m
Type of connection (standard)	M12 connector, 12 pin
Electrical characteristics	
Supply voltage	10 ... 30 V DC ±10%
Residual ripple	< 10 %
Current consumption	max. 150 mA
Reverse polarity protection	yes
Short circuit proof	yes
Accuracy	
Measuring principle	absolute + incremental (option)
System accuracy at 20 °C [+68 °F]	max. ± (10 + 20 x L) µm L = measuring length in meters
Repeat accuracy	±1 increment
Resolution	0.001 mm
LED, red	lights up when distance too large
SSI interface	
Output driver	RS485 transceiver type
Permissible load / channel	max. ±20 mA
Signal level	HIGH typ. 3.8 V LOW at I _{Load} = 20 mA typ. 1.3 V
Clock rate	25 bit (24 + 1 failurebit for distance)
Code	Gray
SSI clock rate	80 kHz ... 0.4 MHz
Monoflop time	≤ 40 µs
Data refresh rate	≤ 250 µs
CANopen interface	
Interface	CAN High-Speed acc. to ISO 11898, Basic and Full CAN, CAN specification 2.0 B
Protocol	CANopen
Baud rate	standard 250 kbit/s on request other baud rate (125 ... 1000 kbit/s)
Termination	selectable via order code
Node address	1 (standard); others on request
Option SinCos interface	
Max. frequency -3dB	400 kHz
Signal level	1 V _{pp} (±10%)
Short circuit proof	yes
Pulse rate	1 SinCos per 1 mm pole
Approvals	
CE compliant in accordance with	
EMC Directive	2014/30/EU
RoHS Directive	2011/65/EU

1) XXXX = cable length in meters (e.g. 10 m = 0010).

Linear measuring technology

Absolute magnetic measurement system sensor head, magnetic band	Limes LA10 / BA1	Measuring length max. 8 m Resolution min. 1 µm
--	-------------------------	---

Magnetic band Limes BA1	
Pole gap	basic pole pitch 1 mm
Dimensions	width 10 mm
	thickness 1.97 mm incl. masking tape
Relative linear expansion	$\Delta L = L \times \alpha \times \Delta\delta$ L = measuring length in meters α = 16×10^{-6} 1/K temperature coefficient $\Delta\delta$ = relative temperature change based on 20 °C [+68 °F] in °K

Working temperature	-20 °C ... +80 °C [-4 °F ... +176 °F] ¹⁾
Mounting	adhesive joint
Additional length	100 mm in order to obtain an optimal measuring result, the magnetic band should be about 0.1 m longer than the required measuring length
Min. bending radius for storage	≥ 150 mm
Material metal tape	precision steel strip 1.4404 acc. to EN 10088-3

Terminal assignment

<i>Output circuit</i>	Type of connection	M12 connector, 12 pin													
1	2	Signal:	0 V	+V	C+	C-	D+	D-	-	-	-	-	-	-	
		Pin:	1	2	3	4	5	6	7	8	9	10	11	12	
<i>Output circuit</i>	Type of connection	M12 connector, 12 pin													
2	2	Signal:	0 V	+V	C+	C-	D+	D-	A	\bar{A}	B	\bar{B}	-	-	
		Pin:	1	2	3	4	5	6	7	8	9	10	11	12	
<i>Output circuit</i>	Type of connection	M12 connector, 12 pin													
3, 4	2	Signal:	0 V	+V	CAN_L	CAN_H	-	-	-	-	-	-	-	-	
		Pin:	1	2	3	4	5	6	7	8	9	10	11	12	
<i>Output circuit</i>	Type of connection	M12 connector, 12 pin													
5, 6	2	Signal:	0 V	+V	CAN_L	CAN_H	-	-	A	\bar{A}	B	\bar{B}	-	-	
		Pin:	1	2	3	4	5	6	7	8	9	10	11	12	

- +V: Supply voltage encoder +V DC
- 0 V: Supply voltage encoder ground GND (0 V)
- C+, C-: Clock signal
- D+, D-: Data signal
- A, \bar{A} : Cosine signal
- B, \bar{B} : Sine signal

Connection cable color assignment with M12 female connector	Connection cable with M12 connector, 12 pin (accessory) – for example 05.00.60B1.B211.005M												
	Core color:	WH	BN	GN	YE	GY	PK	BU	RD	BK	VT	GY/PK	RD/BU
	Pin:	1	2	3	4	5	6	7	8	9	10	11	12

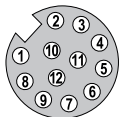

1) Magnetic band (ends) attached by screwing, clamping or equivalent.

Linear measuring technology

**Absolute magnetic measurement system
sensor head, magnetic band**

Limes LA10 / BA1

**Measuring length max. 8 m
Resolution min. 1 µm**

Permissible mounting tolerances

Dimensions in mm [inch]

Distance sensor head / magnetic band (incl. masking tape)

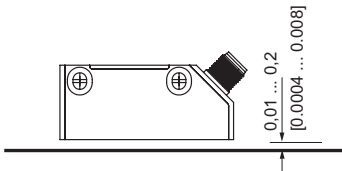

Torsion

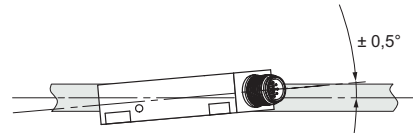

Tilting

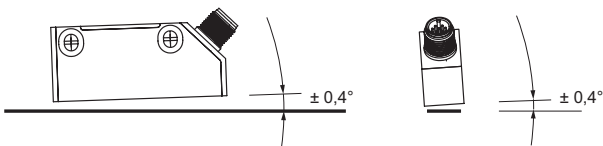

Offset

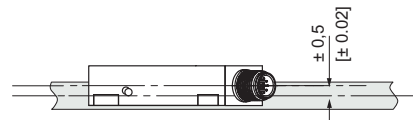

Measuring range

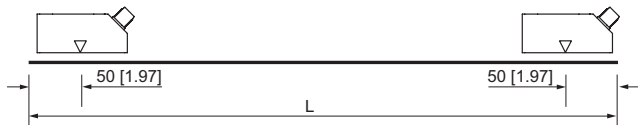

Observe mounting direction



Dimensions

Dimensions in mm [inch]

Sensor head Limes LA10

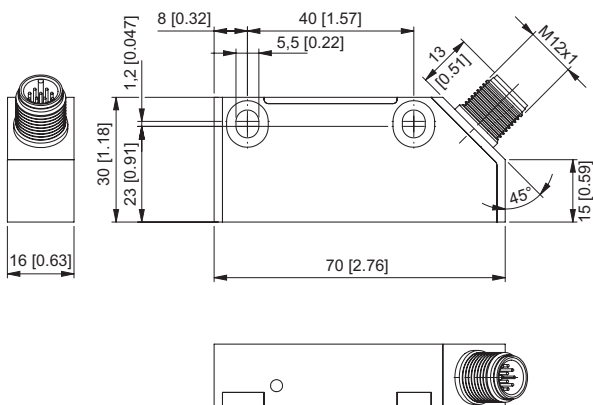

Magnetic band Limes BA1

- 1 Length L, max. 8 m
- 2 Masking tape
- 3 Magnetic band

